

7090A Measurement Plotting
System
Operator's Manual

Hewlett-Packard 7090A Measurement Plotting System Operator's Manual

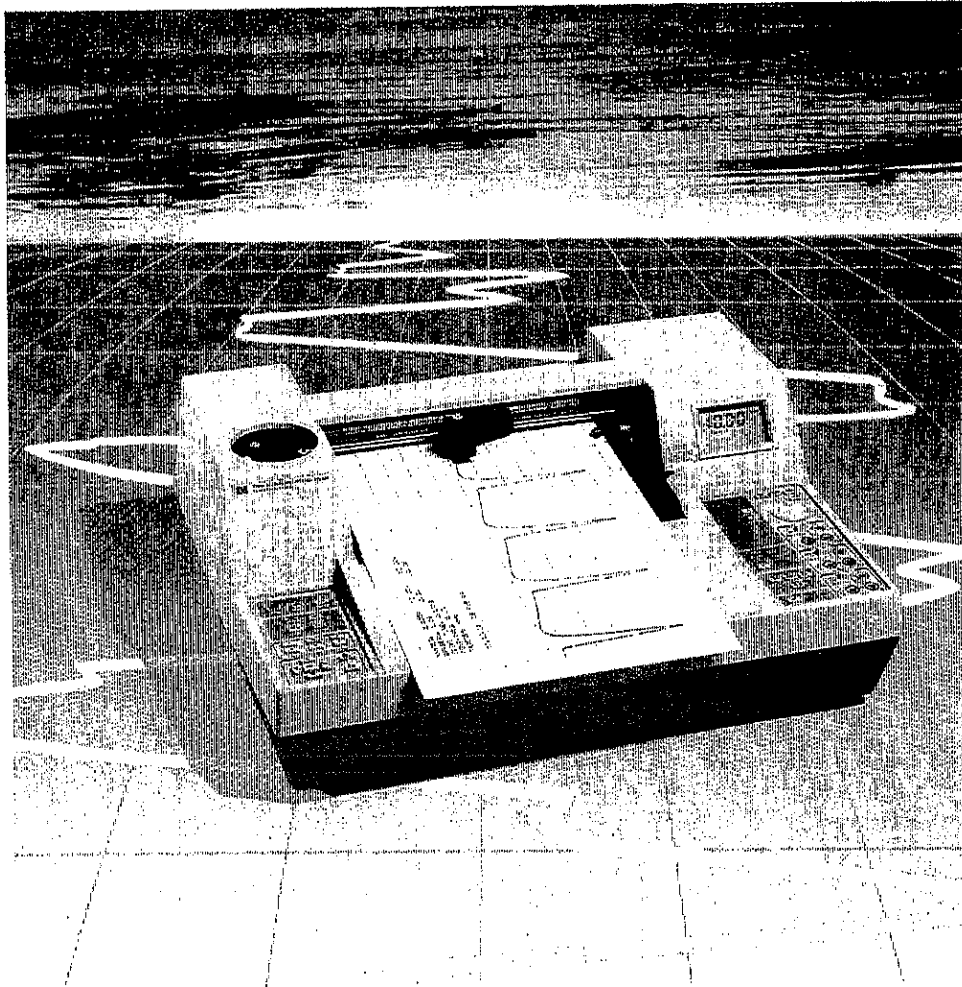

Copyright © Hewlett-Packard Co. 1984, 1986
16399 W. Bernardo Drive, San Diego, California 92127-1899

SAFETY

This product has been designed and tested according to International Safety Requirements. To ensure safe operation and to keep the product safe, the information, cautions, and warnings in this manual must be heeded. Refer to Chapter I for general safety considerations applicable to this product.

CERTIFICATION

Hewlett-Packard Company certifies that this product met its published specifications at the time of shipment from the factory. Hewlett-Packard further certifies that its calibration measurements are traceable to the United States National Bureau of Standards, to the extent allowed by the Bureau's calibration facility, and to the calibration facilities of other International Standards Organization members.

WARRANTY

This Hewlett-Packard product is warranted against defects in materials and workmanship for a period of 1 year from date of shipment. During the warranty period, HP will, at its option, either repair or replace products which prove to be defective.

For warranty service or repair, this product must be returned to a service facility designated by HP. Buyer shall prepay shipping charges to HP and HP shall pay shipping charges to return the product to Buyer. However, Buyer shall pay all shipping charges, duties, and taxes for products returned to HP from another country.

HP warrants that its software and firmware designated by HP for use with an instrument will execute its programming instructions when properly installed on that instrument. HP does not warrant that the operation of the instrument, or software, or firmware will be uninterrupted or error free.

LIMITATION OF WARRANTY

The foregoing warranty shall not apply to defects resulting from improper or inadequate maintenance by Buyer, Buyer-supplied software or interfacing, unauthorized modification or misuse, operation outside of the environmental specifications for the product, or improper site preparation or maintenance.

NO OTHER WARRANTY IS EXPRESSED OR IMPLIED. HP SPECIFICALLY DISCLAIMS THE IMPLIED WARRANTIES OF MERCHANTABILITY AND FITNESS FOR A PARTICULAR PURPOSE.

EXCLUSIVE REMEDIES

THE REMEDIES PROVIDED HEREIN ARE BUYER'S SOLE AND EXCLUSIVE REMEDIES. HP SHALL NOT BE LIABLE FOR ANY DIRECT, INDIRECT, SPECIAL, INCIDENTAL, OR CONSEQUENTIAL DAMAGES, WHETHER BASED ON CONTRACT, TORT, OR ANY OTHER LEGAL THEORY.

ASSISTANCE

Product maintenance agreements and other customer assistance agreements are available for Hewlett-Packard products.

For any assistance, contact your nearest Hewlett-Packard Sales and Support Office.

Using the HP 7090A Documentation	vi
For All HP 7090A Users	vi

Chapter 1

Owner's Information	1-1
Introduction	1-1
Initial Inspection and Accessories Inventory	1-1
Accessories Supplied	1-2
Ventilation Requirements	1-2
AC Power Requirements	1-2
Power Options	1-2
Fuse Protection	1-3
Power Cord	1-3
Grounding Requirements	1-5
Instrument Maintenance	1-5
Cleaning the Exterior Surface	1-5
Cleaning the Pen Carousel	1-5
Cleaning the Air Filter	1-6
The Internal Battery	1-6
Shipping the Instrument	1-6

Chapter 2

Instrument Description and General Operation ...	2-1
Overview of Operating Modes and Functions	2-2
The Direct Recording Mode	2-2
The Buffered Recording Mode	2-2
The Data Display Mode	2-3
Trigger Modes and Conditions	2-3
Labeling Functions	2-3
Major Feature Locations	2-4
Front-Panel Features	2-4
Rear-Panel Features	2-5
Instrument Controls, Indicators, and Connectors	2-5
Right Front Panel	2-5
Left Front Panel	2-7
Right Side Panel	2-9
Rear-Panel Switches	2-9
Preparing the HP 7090 for Use	2-9
Choosing the Correct Pen and Medium	2-9
Loading Pens and the Carousel	2-10
Setting the Paper-Format Switch	2-11
Power-up Initialization/Self-Testing	2-11
Loading the Plotting Medium	2-12
The Demonstration Plot/Confidence Test	2-13
Using the Front-Panel Controls	2-14
The Shift Pushbutton	2-14
The Stop/Initialize Pushbutton	2-15
The Restore Setup/Save Setup Pushbutton	2-15
The Setup Conditions Menu Controls	2-16
The Pen Controls	2-17
Setting the Real-Time Clock	2-18

Table of Contents

Table of Contents

(Continued)

<i>Chapter 3</i>	
Measurement Setup Operations	3-1
The Recording Area	3-1
Defining the Axes/Channel Selection	3-2
Establishing the Recording Area Boundaries	3-4
Clipping	3-4
Positioning the Zero and Full-Scale Points	3-6
Scaling the Recording Area Boundaries	3-8
The Total Time Setup Condition	3-8
The Range Setup Condition	3-9
The Offset Setup Condition	3-13
Scaling and Drawing the Recording Area Grid	3-16
The Grid Divisions Setup Conditions	3-17
Selecting Quadrants and Drawing the Grid	3-18
Rotating the Recording Area	3-20
Connecting Analog Input Signals	3-22
Using the Guard Switch	3-22
Channel Input Signals	3-23
Overflow Conditions	3-24
Displaying Input Voltages	3-24
<i>Chapter 4</i>	
Performing Direct and Buffered Recordings	4-1
The Direct Recording Mode	4-1
Performing a Direct Recording (Versus Time)	4-1
Performing a Direct Recording (Versus Chan3)	4-3
The External-Pen Connector	4-4
The Buffered Recording Mode	4-4
Minimum Sample Rate	4-6
Performing a Buffered Recording (Versus Time or Versus Chan3)	4-7
Displaying and Labeling Buffered Data Points	4-8
Displaying Buffer Contents on an Oscilloscope	4-10
<i>Chapter 5</i>	
Trigger Modes and Operations	5-1
Introduction to Trigger Modes	5-1
Trigger Search Status	5-1
The Manual Trigger Mode	5-2
The External Trigger Mode	5-3
The External Trigger Connector	5-3
The Internal Trigger Mode	5-3
Above-Level and Below-Level Triggering	5-4
Outside-Window Triggering	5-5
Inside-Window Triggering	5-7
Post- and Pre-Trigger Time	5-9
<i>Chapter 6</i>	
Labeling Functions and Operations	6-1
Annotating Measurements	6-1
Printing the Time and Date	6-1
Printing the Trigger Time	6-2
Labeling Setup Conditions	6-2
Positioning Multiple Labels	6-4

<i>Chapter 6</i>	
Labeling Functions and Operations (Continued) ...	6-1
Label Character Size	6-4
Changing Default Character Size	6-6
Positioning P1 and P2	6-7
Rotation of Labels	6-8
<i>Appendix A</i>	
Default Conditions and Values	A-1
<i>Appendix B</i>	
Specifications	B-1
<i>Appendix C</i>	
Supplemental Characteristics	C-1
<i>Appendix D</i>	
Accessories Available	D-1
<i>Subject Index</i>	SI-1

Table of Contents (Continued)

Using the HP 7090A Documentation

The HP 7090A can be used as a stand-alone instrument, or as a programmable input/output-component of a computer-based system. Therefore, two separate manuals are provided — an Operator's Manual, which details front-panel (stand-alone) operations, and an Interfacing and Programming Manual, which details programming operations. A Pocket Guide is also included for use as a quick programming reference.

Using the documentation systematically will help you to achieve optimum results in the shortest possible time, and save hours of frustrating experimentation. Contents of the manuals are summarized below, followed by suggestions on using the documentation based on your application.

Operator's Manual. This manual contains all of the information necessary to perform measurement and plotting operations using front-panel controls. Information is also included on instrument installation and maintenance, how to load pens and paper, and how to use the controls. The remaining chapters detail how to perform measurement operations.

Interfacing and Programming Manual. The Interfacing and Programming Manual contains all of the information you will need to perform remote-controlled operation of the HP 7090A. A complete description of all programming instructions usable for recorder and plotter functions is included, as well as directions on using the HP-IB interface bus to interface the HP 7090A with specific computers.

Pocket Guide. The Pocket Guide is intended for those who are already familiar with the information contained in the Interfacing and Programming Manual, and who need a convenient reference during remote applications of the HP 7090A.

For All HP 7090A Users

If you have just received your HP 7090A, or are just learning to use it, read the following portions of the Operator's Manual before attempting any front-panel or programming operations:

Chapter 1. This chapter will help you setup the HP 7090A. It contains important information on the accessories provided, instrument installation, maintenance, and power requirements.

Chapter 2. This chapter will acquaint you with the HP 7090A's major features, controls, and operating modes. In addition, it explains how to load pens and paper in preparation for measurement and plotter applications.

Chapter 3. The section in this chapter entitled "Connecting Analog Input Signals" contains information on connecting input intended for measurement. To prevent damage to the HP 7090A, be sure to read this section before performing any measurement operations.

After reading the above introductory material, refer to the manual that is suitable for your application. If you intend to use the HP 7090A as a stand-alone instrument, read the remaining portions of the Operator's Manual. On the other hand, if you intend to interface the HP 7090A with a host computer and perform programming operations, read the Interfacing and Programming Manual, using the operator's manual as an additional source of information. After you are comfortable with using the HP 7090A programming instructions, the Pocket Guide can be used as a handy reference.

Chapter 1 Owner's Information

Getting Started

Before you begin to use the plotter, please read the following information carefully. It contains important safety and operating instructions that will help you get the most out of your plotter. Please read this information carefully and keep it for future reference.

Initial Inspection and Accessories Inventory

When you receive your plotter, please inspect it carefully for any damage. If you find any damage, please contact your dealer immediately. Also, please check the accessories inventory to make sure you have all the items listed. If you are missing any items, please contact your dealer immediately.

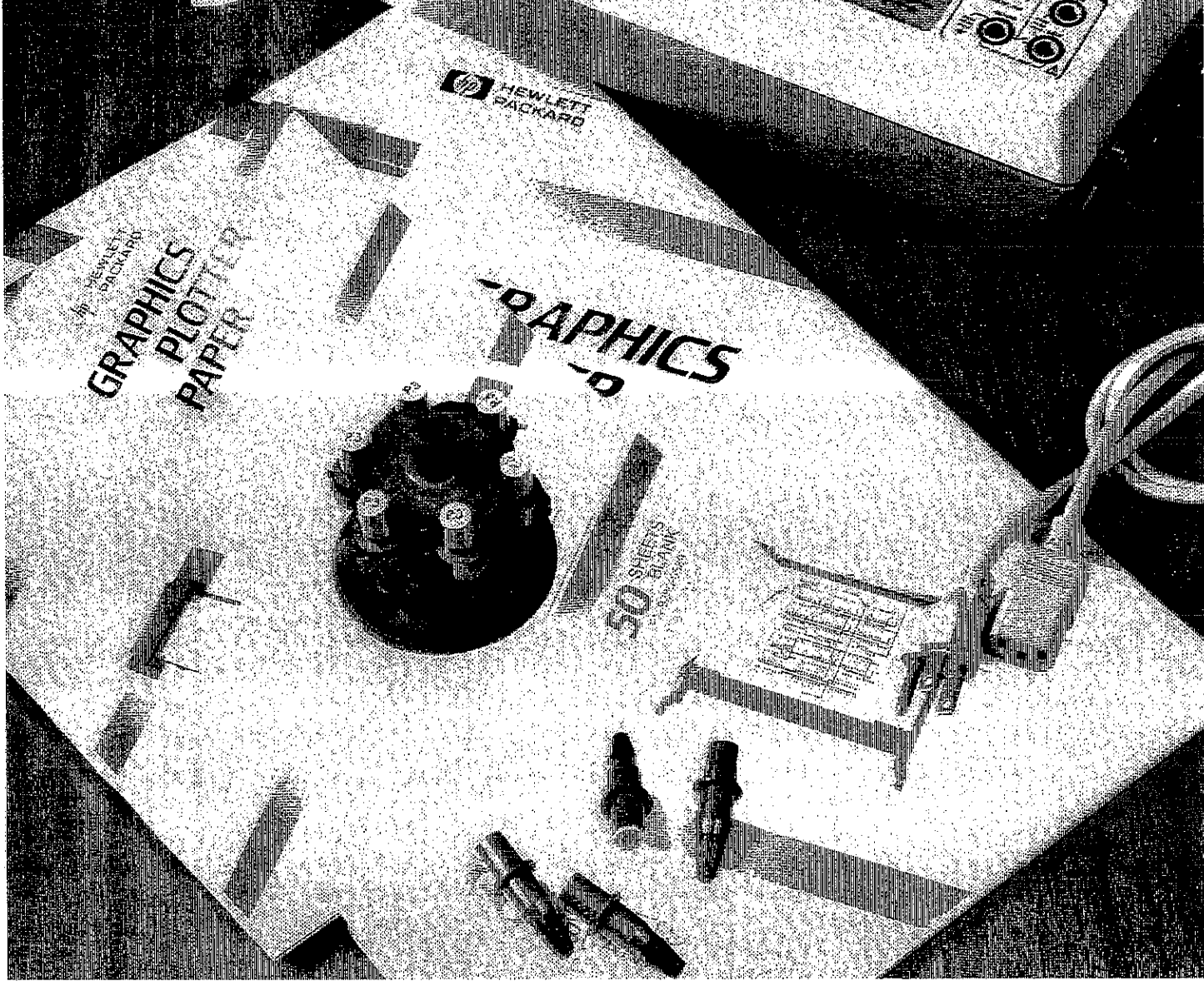
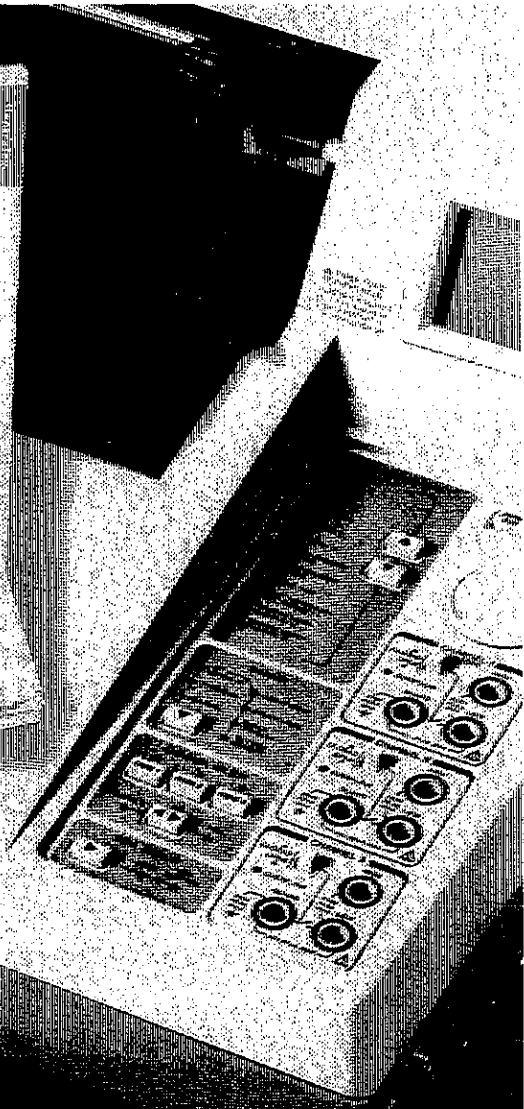

Chapter 1

Owner's Information

Introduction

This manual contains information on preparing the HP 7090 for operation, followed by detailed instructions on using the front-panel controls to perform measurements. Because the HP 7090 is a versatile and innovative instrument, it is suggested that you read and apply the material in this manual as it is presented. Doing so will familiarize you with all the available front-panel functions.

Throughout this manual, words printed in boldface (e.g., **PLOT BUFFER**) refer to controls, indicators, connectors, or labeling found on the HP 7090. Words printed in capital letters and contained in quotation marks (e.g., "VOLTS") denote information displayed on the instrument's liquid-crystal display. In addition, this manual contains some information and warnings which have to be followed to ensure safe operation and to prevent damage to the instrument.

The HP 7090 is intended for indoor use, has been designed and tested in accordance with the IEC Publication 348, Safety Requirements for Electronic Measuring Apparatus, and has been supplied in a safe condition. Whenever it is likely that the protection of the instrument has been impaired (due to transport or storage stress, for example) do not attempt to operate the apparatus.

Initial Inspection and Accessories Inventory

The individual parts of your Measurement Plotting System were inspected before the unit was shipped to you, and the instrument should be in good operating order. Carefully inspect the HP 7090 and accessories for any damage sustained in transit. If the unit is received in damaged condition, notify your nearest HP Sales and Support Office and file a claim with the carrier.

Please check to ensure that you have received all of the accessories that should accompany the HP 7090. Refer to the following table of Accessories Supplied. If any accessories are missing, if you have any difficulties with the instrument, or if it is not operating properly, contact the nearest HP Sales and Support Office.

Retain the original packing materials and carton. If the instrument must be shipped, this will save having to order new packing materials and carton from Hewlett-Packard.

Accessories Supplied

The following items are supplied with each HP 7090 Measurement Plotting System:

Item	Quantity	Part Number
Interfacing and Programming Manual	1	07090-90001
Operator's Manual	1	07090-90002
Pocket Guide	1	07090-90004
Customer Survey Card	1	5957-4108
HP Sales and Support Offices	1	5958-2682
Warranty Overview	1	5955-7440
Power Cord (appropriate cord supplied, based on origin of sales order)	1	—
Fiber-tip carousel	1	5061-5080
Assorted pen and media samples	—	—

Ventilation Requirements

The HP 7090 uses fan-circulated air for cooling. When installing the instrument allow at least 2 inches of clearance on all sides to permit ventilation. Do not block the fan filter on the rear panel or the vent slots on the sides of the instrument housing.

AC Power Requirements**WARNING**

To prevent operator injury or damage to the instrument, verify that the line voltage setting and fuse protection are correct before connecting the line power. Also, ensure the line power cord is connected to a line power outlet having a protective earth ground contact.

Power Options

The HP 7090 can be configured to operate with any of the following power sources. Maximum power consumption of the HP 7090 for the listed line voltages is 140 Watts.

Line Voltage ~ +5%, -10%	Line Current (Max.)	Line Frequency (single phase)
100 V	1.8 A	48-66 Hz
120 V	1.6 A	48-66 Hz
220 V	0.9 A	48-66 Hz
240 V	0.8 A	48-66 Hz

The HP 7090 is shipped from the factory with the line voltage set to the proper value for the area specified as the shipment's destination. The voltage selected for the instrument is identified on the rear panel. The line voltage may be changed by qualified service personnel only.

Fuse Protection

The HP 7090 is factory equipped with a line fuse appropriate to the factory-set line voltage. Only specified fuses should be used for replacement. To change or inspect the fuse, turn the fuseholder on the rear panel counter-clockwise until the fuseholder releases. Remove the fuseholder and insert a "slow-blow" fuse that corresponds with the appropriate voltage setting, as listed below. Place the fuseholder back into the fuse socket and, while pressing in, turn the fuseholder clockwise until the lock engages.

Voltage	Fuse Rating	HP Part Number
100 V or 120 V	2.5 AT (SB)/250 V	2110-0015
220 V or 240 V	1.25 AT (SB)/250 V	2110-0305 (U.S.) or 2110-0472 (European)

WARNING





To avoid the possibility of injury, disconnect the ac power cord before installing or replacing a fuse.

NOTE: Fuses and fuse caps appropriate to the instrument shipment destination are installed at the factory. U.S. fuses are $\frac{1}{4} \times 1\frac{1}{4}$ inches and use HP 2110-0565 fuse caps. European fuses are 5×20 millimetres and use HP 2110-0567 fuse caps. ■

Power Cord

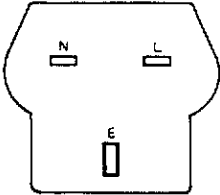
The power cord provided with the HP 7090 was chosen to be compatible with the line power outlets available at the shipment destination. The cord's female socket, which connects with the power-input plug on the instrument, is standard on all cords. The male plug, which inserts into your line power outlet, is configured for the shipment destination. If your HP 7090 has the wrong power cord for your requirements, please contact your local HP Sales and Support Office. The following chart shows the available power cord plug options and their HP part numbers.

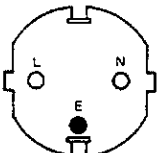
Power Cord Configurations

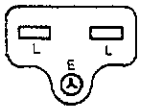
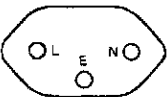
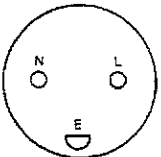
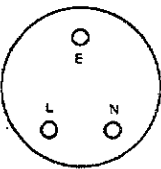
		<u>Option No.</u>
<p>BS 1363A</p> 	<p>HP Part Number 8120-1351; 250 V, 13 A, 1 ϕ plug rating. For use in United Kingdom, Cyprus, Nigeria, Zimbabwe, Singapore.</p>	900
<p>AS C112</p> 	<p>HP Part Number 8120-1369; 250 V, 10 A, 1 ϕ plug rating. For use in Australia, New Zealand.</p>	901
<p>CEE 7-VII</p> 	<p>HP Part Number 8120-1689; 250 V, 10/16 A, 1 ϕ plug rating. For use in East and West Europe, Egypt.</p>	902
<p>NEMA 5-15P</p> 	<p>HP Part Number 8120-1378; 125 V, 15 A, 1 ϕ plug rating. For use in Canada, Japan, Mexico, Philippines, Taiwan, Saudi Arabia, UL approved in United States.</p>	903
<p>NEMA 6-15P</p> 	<p>HP Part Number 8120-0698; 250 V, 15 A, 1 ϕ plug rating. For use in Canada, UL approved in United States.</p>	904
<p>SEV 1011</p> 	<p>HP Part Number 8120-2104; 250 V, 10 A, 1 ϕ plug rating. For use in Switzerland.</p>	906
<p>DHCK-107</p> 	<p>HP Part Number 8120-2956; 250 V, 10 A, 1 ϕ plug rating. For use in Denmark.</p>	912
<p>SABS-164</p> 	<p>HP Part Number 8120-4211; 250 V, 10 A, 1 ϕ plug rating. For use in India, Republic of South Africa.</p>	917

NOTE: All plugs are viewed from connector end.

L = Line or Active Conductor (also called "live" or "hot")
 N = Neutral or Identified Conductor
 E = Earth or Safety Ground

To ensure safe operating conditions, the HP 7090 must be properly grounded. The three-conductor power cord supplied grounds the instrument when plugged into a grounded three-wire power outlet. Do not operate the HP 7090 from a power outlet that has no earth ground connection.

Grounding Requirements

WARNING

Any interruption of the protective earth ground connector inside or outside the HP 7090 may create a shock hazard.

Instrument Maintenance

Maintenance of the HP 7090 is limited to a periodic cleaning of the external surfaces, pen carousel, and air filter. Cleaning intervals will depend upon instrument workload and environmental conditions.

WARNING

Disconnect the HP 7090 from the power source before performing any maintenance. Do not allow water to run onto electrical components and circuits, as this may create a shock hazard.

Clean the outer surface of the HP 7090 as follows:

1. Blow away dust accumulation with compressed air, if available.
2. Clean the outer surface with a damp sponge or lint-free cloth. Use a mild cleaning solution if necessary, followed by water to rinse off any residue. Wipe dry after cleaning.
3. Clean inside the plastic sleeves of the **HIGH**, **LOW**, and **GUARD** input terminals with a cotton-tipped swab and isopropyl alcohol.

NOTE: To prevent scratching, do not use abrasive cleaners on the outer surface of the HP 7090. In addition, some cleaning solvents or detergents may damage plastic surfaces. For this reason, a 50:50 mixture of isopropyl alcohol and water is recommended as a safe, effective cleaning solution. ■

CAUTION

Do not attempt to clean the paper-drive grit wheels. Cleaning solutions may dissolve the adhesive that secures the grit particles to the wheels. Accumulated dust may be blown off with compressed air.

Cleaning the Exterior Surface

Clean the pen carousel periodically to remove ink, lint, or dust deposits. Wipe out the pen caps with a cotton swab moistened with alcohol or pen cleaning solution, as shown by the following illustration. Allow the carousel to dry thoroughly before inserting pens.

Cleaning the Pen Carousel

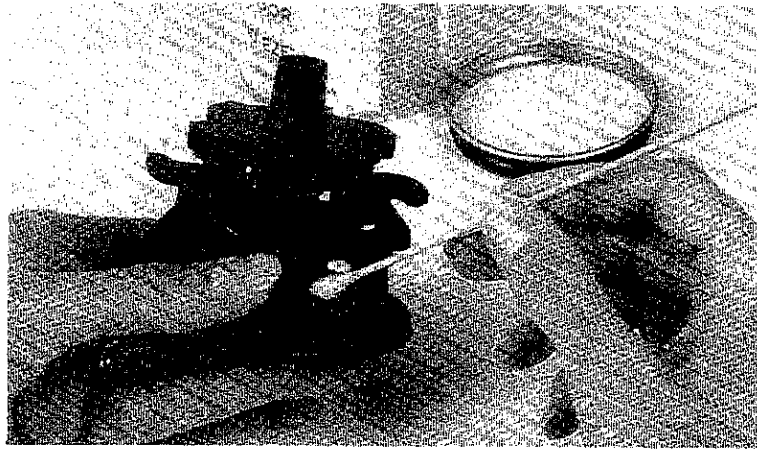

7475-A-39-1

Cleaning the Air Filter

The air filter located on the rear panel should be cleaned approximately every three months or if dirt becomes visible on the filter surface. To clean, remove the filter and either hold it under running water or wash it in warm, soapy water followed by a rinse in clean water. Dry the filter thoroughly before replacing it.

The Internal Battery

An internal, lithium battery is used by the HP 7090 to run the real-time clock when the power is turned off. Under normal environmental and operating conditions, battery-life should be about two years. The battery should be replaced by qualified personnel only. If necessary, it will be replaced when your HP 7090 is returned to Hewlett-Packard for routine service maintenance.

Shipping the Instrument

When shipping the HP 7090, be sure it is packed in a protective carton. Keep the original packing materials and shipping carton for this purpose. If needed, packing materials and carton may be ordered through your local Hewlett-Packard Sales and Support Office.

If your plotter is being returned to Hewlett-Packard for service, contact your nearest HP Sales and Support Office for complete shipping instructions. You can help assure effective servicing of your instrument by following these guidelines:

1. Follow the instructions in this manual to make certain the malfunction is a result of instrument error and, if possible, identify the defective area or function.
2. If you determine that repair is required, please include the following items when the instrument is returned for service:
 - a. A description of all measurement setup conditions, operating modes, trigger modes, and operating procedures that were used when the malfunction occurred.

- b. A description of the exact configuration at the time of malfunction, including the signal input source(s), controller and interface used (if any), and any other accessories that were in use when the malfunction occurred.
 - c. A brief description of instrument symptoms for service personnel. Include any error codes which may be displayed on the liquid-crystal display (error codes appear as "E", followed by a code number).
 - d. Hardcopy graphics produced on the HP 7090 (or any other materials) that might help illustrate the problem area.
 - e. The serial number of the instrument (located on the rear panel).
3. Include your name and address. Also include a telephone number where you may be reached during the day.
 4. Do not include the power cord or any other operating accessories with the instrument, unless the problem relates to an accessory.



Chapter 2

Instrument Description and General Operation

Overview of Operating Modes and Functions

The HP 7090 combines the capabilities of several measurement graphics devices. As a stand-alone instrument it can function as an X-Y recorder, a waveform recorder, or a digital voltmeter. Three channels are available for receiving analog input signals. Each channel uses its own analog-to-digital (A/D) converter to digitize the analog input, and the resulting digital information is routed according to the functions or modes that you select from the front panel. The following block diagram shows the major operating modes and functions of the HP 7090 and the selectable routes of digitized data.

Front-Panel Operating Modes and Functions

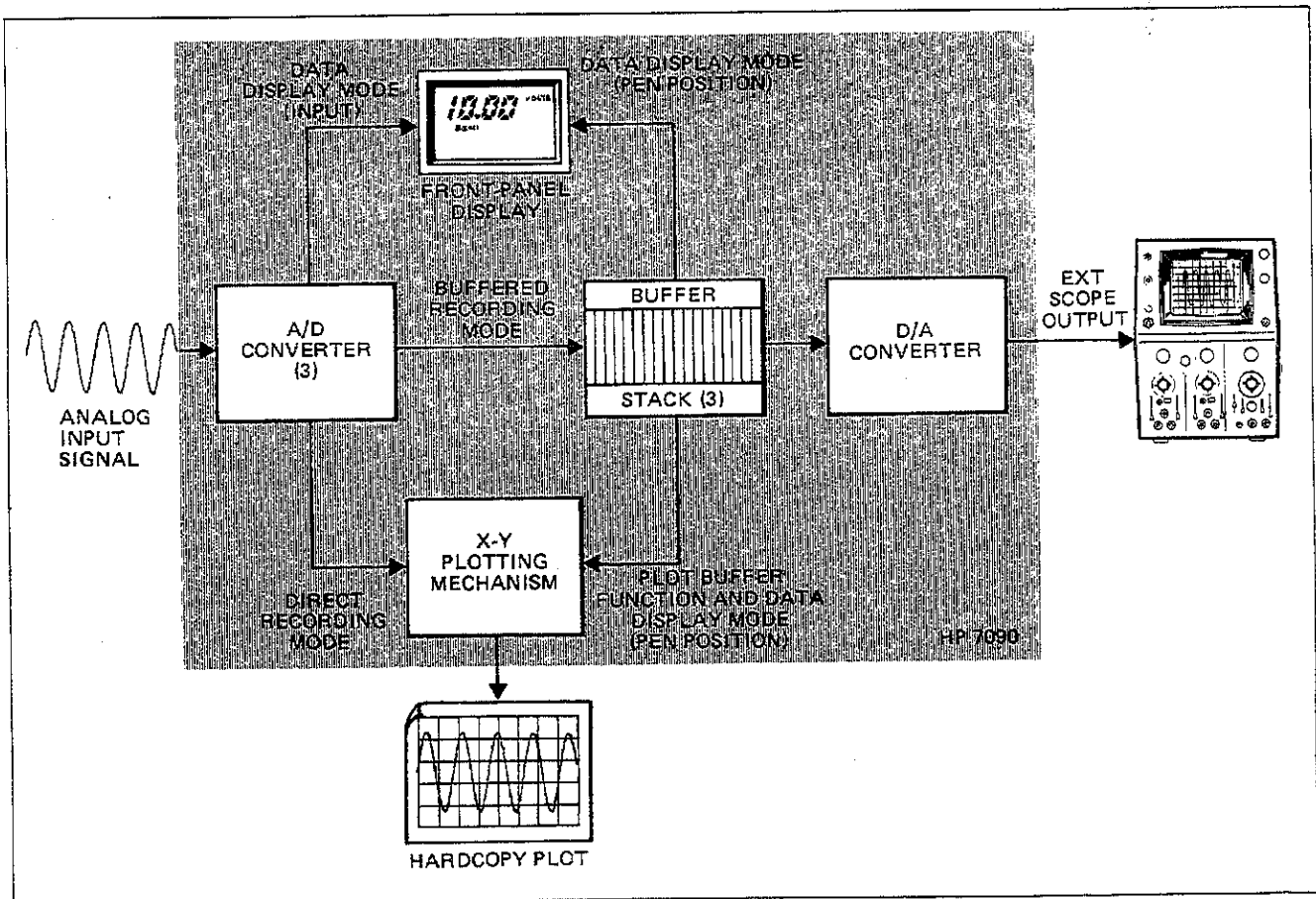

When used with a computer, the HP 7090 will also serve as the front end of a data acquisition system or as a graphics plotter. (This manual details all of the instrument's stand-alone capabilities. For data acquisition and graphics plotter applications, refer to the Interfacing and Programming Guide.)

The *direct* or *buffered recording modes* are used to produce hardcopy plots of measurement data. Measurements are plotted by the HP 7090 onto the *recording area*, a specified area on the plotter paper. The following illustration shows a typical hardcopy plot. You can specify the size, orientation, and scaling of the recording area, as well as the number of grid divisions used for the X- and Y-axes.

*Plotted
Measurement Data*

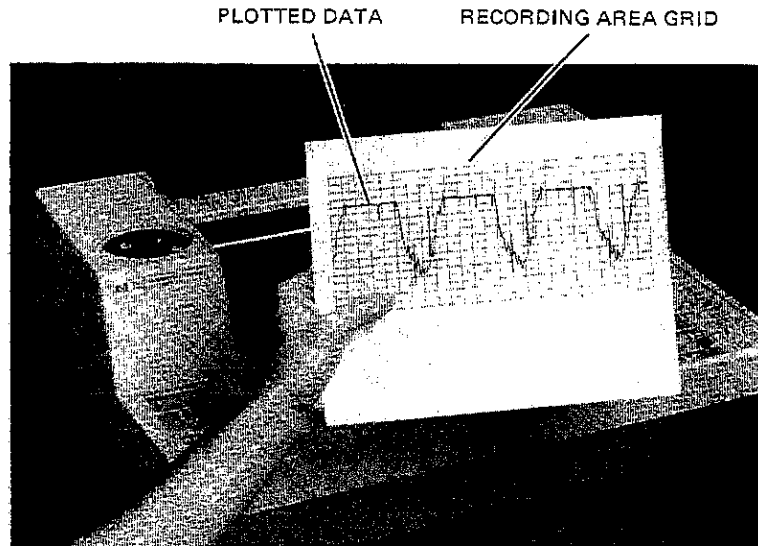

The Direct Recording Mode

The direct recording mode is used to produce real-time recordings on paper. During a direct recording, digitized data is routed directly to the X,Y plotting mechanism. Any of the input channels can be selected for plotting against time (*versus-time measurements*). In addition, measurements can be made for which the Channel 1 or Channel 2 input is selected for plotting against Channel 3 (*versus-chan3 measurements*).

The Buffered Recording Mode

The HP 7090 contains three buffers (one for each channel) that are used to store digitized input-signal data during buffered recordings. Each buffer is capable of storing 1000 data-point values. During a buffered recording, the input buffers are filled simultaneously. This buffered data can, in turn, be recalled and plotted by invoking the *plot buffer function*. Versus-time or versus-chan3 plots of buffered data can be produced, and multiple plots can be drawn from a single buffered recording.

An external scope output is provided on the right side panel. Connecting an oscilloscope to this output enables you to view buffered data on the scope during or following a buffered recording. Any or all of the channel buffers may be selected for viewing.

The data display mode is used to display digitized voltage values on the liquid-crystal display (LCD). Two data display functions are available. The *input data-display function* displays digitized voltage obtained directly from a selected channel's A/D converter, allowing the HP 7090 to be used as a digital voltmeter. The *pen position data-display function* is used to "trace" buffered recording plots and display individual buffered voltage values on the LCD. The pen position function may also be used to label the X- and Y-coordinate values of points-of-interest on buffered recording plots.

The Data Display Mode

You can specify how and when direct or buffered recordings will be triggered by specifying trigger modes and conditions on the front panel. Recordings can be triggered manually by pressing a front-panel push-button, or as the result of specified external or internal events. Trigger modes and conditions are detailed in Chapter 5.

Trigger Modes and Conditions

Labeling functions can be invoked from the front panel to annotate your hardcopy plots. Selectable labels include measurement conditions, current time and date, and the time at which a recording trigger occurred. Labeling functions are detailed in Chapter 6.

Labeling Functions

Major Feature Locations

The following illustrations show the locations of the major features of the HP 7090. The illustrations are numerically keyed to the accompanying descriptions.

Front-Panel Features

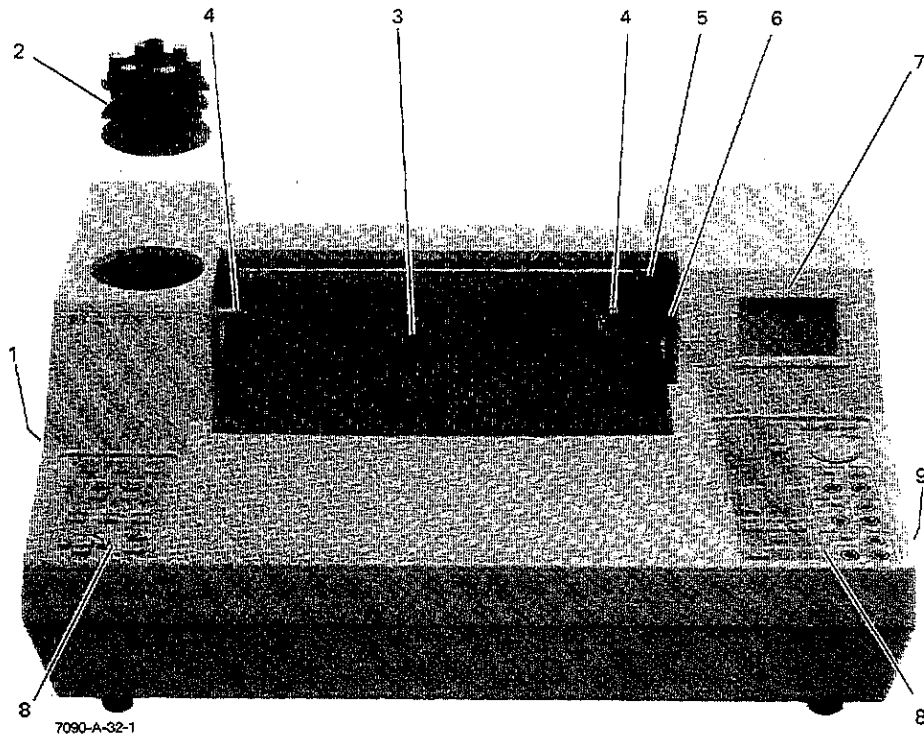

1. **Line Power Switch.**
2. **Pen Carousel (removable):** Holds up to six pens, which are accessible to the pen holder.
3. **Platen:** Provides a surface for the plotter paper.
4. **Pinch Wheels and Drive Wheel:** Grip the paper during plotting. The grit-covered drive wheel moves the paper back and forth across the platen.
5. **Pen Holder:** Maneuvers the pens during plotting operations.
6. **Paper Loading Lever:** Used to raise or lower the pinch wheels during insertion or removal of paper.
7. **Liquid-Crystal Display (LCD):** Displays measurement parameters and other pertinent data.
8. **Left and Right Front Panels:** Includes the controls, indicators, and connectors used during measurement/plotter operations.
9. **Right Side Panel:** Includes the connectors used to establish auxiliary connections.

Rear-Panel Features

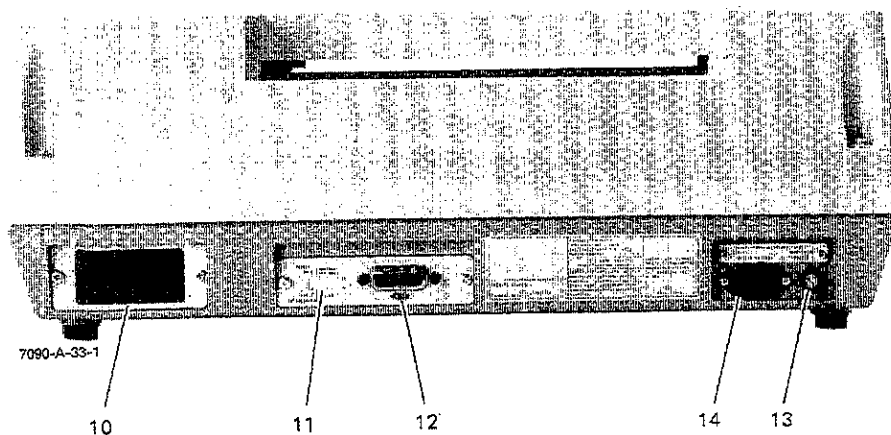

10. Air Filter.

11. DIP Switch Assembly: Used to select between metric (ISO) and English (ANSI) paper formats, and to establish the HP-IB bus address for computer or controller interfacing.

12. HP-IB Bus Connector: Used to interface the HP 7090 with a host computer or controller.

13. Fuse Holder and Fuse.

14. Line Power Socket.

Instrument Controls, Indicators, and Connectors

The following list is intended to familiarize you with the location and function of the HP 7090 controls, indicators, and connectors. For a detailed explanation of any listing, refer to the appropriate section of this manual.

Some of the pushbuttons described below serve two functions — the secondary functions, (called *shift functions* and labeled in blue on the front panel) are accessed by first pressing the blue **SHIFT** pushbutton to display “SHIFT” on the LCD. This manual uses the notation (**SHIFT**) before the function title to denote shift functions.

The right front-panel controls and indicators are primarily used for setting up the HP 7090 before performing a measurement. For example, values may be assigned to various setup condition parameters (e.g., range, offset), trigger modes and conditions may be specified, and input channels may be selected for plotting.

Right Front Panel

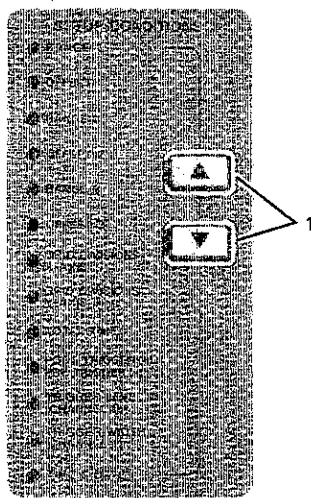

The following description of right front-panel controls and indicators is numerically keyed to the accompanying figures.

1. Setup Condition Selectors and Indicators: Used to select setup condition choices. The current value of any selected condition is displayed on the LCD and may be altered using the control wheel. The following setup conditions are available:

- **range** — sets channel input range and sensitivity.
- **offset** — offsets zero position of input signal.
- **grid divisions** — specifies the number of grid divisions to be drawn on the recording area's X- and Y-axes.
- **total time** — specifies recording time.
- **post-trigger/pre-trigger** — sets delay time between trigger and recording; sets amount of pre-trigger buffered recording.
- **trigger level** — specifies Channel 1 voltage level required to trigger recordings; specifies center voltage of trigger windows.
- **trigger width** — specifies voltage width of trigger windows.
- **time and date** — sets internal real-time clock (accessible with **SHIFT** pushbutton only).

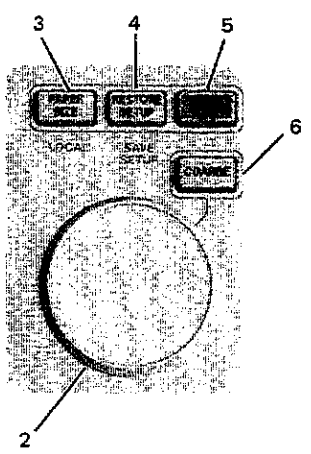

2. Control Wheel: Rotated to establish setup condition values.

3. PAPER SIZE Pushbutton: Used to select paper size. Toggles between 8.5 × 11 and 11 × 17 inches (with rear-panel paper format switch set to ANSI) or between A4 and A3 (with rear-panel paper-format switch set to ISO). Current paper size selection is displayed on the LCD.

(SHIFT) **LOCAL:** Used to restore the HP 7090 to local mode following a computer-issued RL1 (remote) instruction, which “locks out” the front-panel controls during remote applications.

4. RESTORE SETUP Pushbutton: Used to restore from nonvolatile memory the set of front-panel setup values and modes stored previously using the **STORE** pushbutton.

(SHIFT) **SAVE SETUP:** Stores the currently selected front-panel setup values and modes in nonvolatile memory.

5. SHIFT Pushbutton: Accesses secondary functions (labeled in blue) of dual-function pushbuttons. Toggles between active (“SHIFT” displayed on LCD before dual-function pushbutton is pressed) and inactive (“SHIFT” not displayed before dual-function pushbutton is pressed).

6. COARSE Pushbutton: Permits coarse, rapid tuning of setup condition values. Toggles between active (“COARSE” displayed on LCD) and inactive (“COARSE” display extinguished, permitting fine-tuning with control wheel).

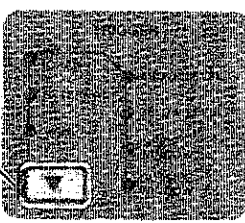

7. Trigger Mode Selector and Indicators: Used to select trigger mode.

8. **Channel Select Pushbuttons and Indicators (Y-Axis):** Used to select the channel input(s) for plotting along the Y-axis.
9. **Channel Select Pushbutton/Indicators (X-Axis):** Used to select either time or the Channel 3 input for plotting along the X-axis.

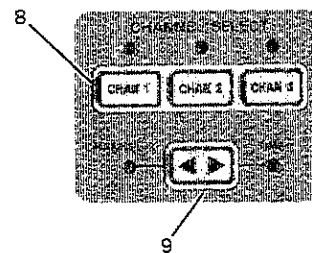

10. **DATA DISPLAY Selector:** Accesses the **INPUT** or **PEN POSITION** functions of the data display mode. (The pen position function is not accessible if the buffers are empty.

(SHIFT) **DATA DISPLAY:** Labels the coordinates of the plotted data point at the current pen position when the pen position data-display mode is active.

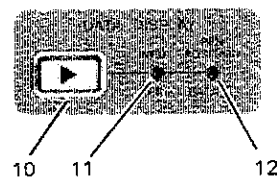

11. **INPUT Indicator:** Lights when the input data-display function is accessed. The input function displays the input voltage of the selected Y-axis channel on the LCD.

12. **PEN POSITION Indicator:** Lights when the pen position data-display function is accessed. Enables the pen cursor controls to be used to trace plotted buffer data and display buffered voltage values.

13. **Guard Switch** (one per channel): When closed ("in" position), provides internal guarding. Opened ("out" position) when using an external guard connection.

14. **OVERFLOW Indicator** (one per channel): Lights when the channel input signal exceeds the voltage range established by the corresponding channel **RANGE** and **OFFSET** setup conditions.

15. **Signal Input Jack** (one set per channel): Receives the analog input signal. Inputs are floating, guarded, and accept a dual banana plug.

16. **Guard Terminal** (one per channel): Used to achieve an external guard connection. Accepts a single banana plug.

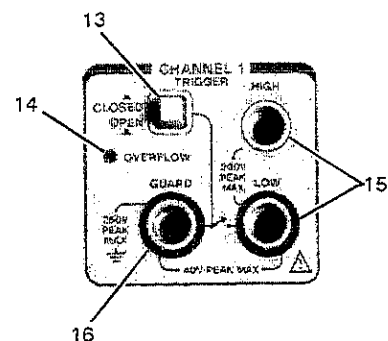

The left front-panel controls and indicators are primarily used for initiating recordings, plotting and labeling measurements, and selecting and positioning pens.

Left Front Panel

1. **RECORD DIRECT Pushbutton:** Used to initiate direct recordings.
2. **TRIGGER SEARCH Indicator:** Lights during a trigger search; blinks on and off while a post-trigger time is elapsing.
3. **FILL BUFFER Pushbutton:** Used to initiate buffered recordings.
4. **BUFFER FILLED Indicator:** Blinks on and off while the buffers are filling; lights when the buffers are filled.
5. **STOP Pushbutton:** Used to manually terminate measurement or plotting functions.

(SHIFT) **INIT:** Used to initialize setup conditions and front-panel selections to their power-up default status.

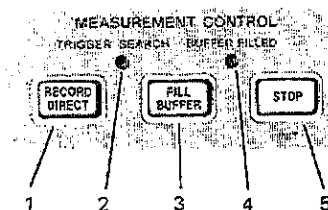

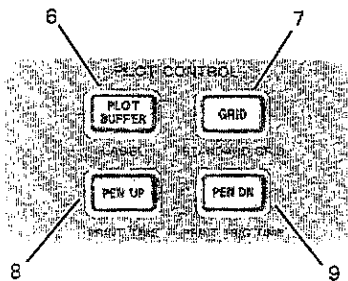

6. PLOT BUFFER: Used to plot the current contents of the selected channel buffer(s).

(SHIFT) LABEL: Used to label the current setup conditions.

7. GRID Pushbutton: Used to draw specified grid on paper for receiving plotted measurements.

(SHIFT) STANDARD GRID: Used to draw a standard 1-cm grid on the default recording area.

8. PEN UP: Used to raise the pen.

(SHIFT) PRINT TIME: Used to label the current time and date.

9. PEN DN: Used to lower the pen.

(SHIFT) PRINT TRIG TIME: Used to label the most recent trigger time.

10. PEN SELECT Pushbuttons: Used to select correspondingly-numbered pen from the pen carousel.

(SHIFT) PEN SELECT Pushbuttons: Returns correspondingly-numbered pen to carousel.

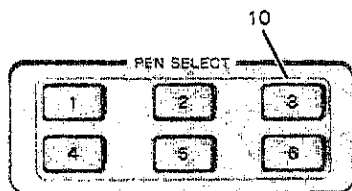

11. Pen Cursor Controls: Used to position the pen on the plotting medium. The FAST pushbutton, when pressed with a cursor control, increases the pen positioning speed.

12. FULL SCALE Pushbutton and Indicator: Used to locate or reposition the full-scale point, a location on the plotting medium representing full-scale input.

When the pushbutton is pressed, the indicator lights and the pen moves to the current full-scale location. The pen cursor controls can then be used to reposition the full-scale point. Pressing FULL SCALE a second time extinguishes the indicator and enters the new full-scale location.

(SHIFT) P2: Used to locate or reposition P2, a scaling point on the plotting medium used in digital plotter modes. The relative positions of P1 and P2 determine label character size.

P2 is located, repositioned, and entered in the same way as the full-scale point, except SHIFT is pressed before pressing P2.

13. ZERO Pushbutton and Indicator: Used to locate or reposition the zero point, a location on the plotter paper representing zero input.

The zero point is located, repositioned, and entered in the same way as the full-scale point.

(SHIFT) P1: Used to locate or reposition P1, a scaling point on the plotting medium used in digital plotter modes.

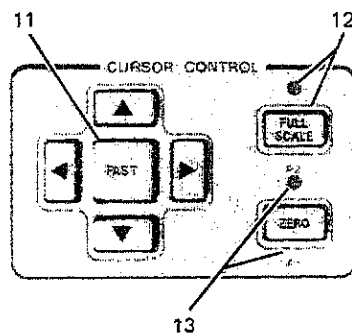

The following auxiliary connectors are available on the right side panel:

1. **GROUND:** Provides ground connection to the signal source chassis ground when required.
2. **SCOPE OUT (vertical and horizontal):** Provides analog output of selected buffer contents to an external oscilloscope.
3. **EXT PEN:** Provides external pen control during manually-triggered, versus-chan3, direct recordings. A falling TTL level or contact closure to ground applied to the connector lowers the pen; a rising TTL level or opening the ground contact raises the pen.
4. **EXT TRIG:** Provides external triggering of recordings. With the external trigger mode selected and a trigger search in effect, a falling TTL level or contact closure to ground applied to the connector triggers the recording.

Right Side Panel

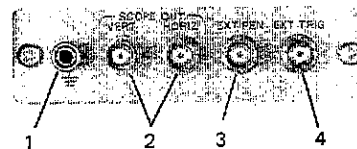

Rear-Panel Switches

1. **ISO/ANSI Paper Format Switch:** Used to select metric (ISO) or English (ANSI) paper format.
2. **LISTEN ONLY/NORMAL Address Mode Switch:** Used to select the addressable or listen-only mode when interfacing the HP 7090.
3. **ADDRESS Switches:** Used to set the HP-IB address switch when interfacing the HP 7090; factory-set to 5.

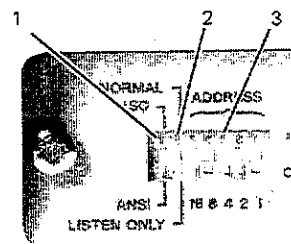

Preparing the HP 7090 for Use

Setting up your HP 7090 is a simple procedure that consists of loading pens into the carousel, inserting the carousel into its receptacle, turning on the power, and loading the plotting medium. This section describes these procedures.

To obtain plots of the highest quality, it is important to use pens and media that are matched to your application. The fiber-tip pens provided with your HP 7090 are designed for use with standard plotter paper. The top of each HP plotter pen is marked with a letter and number in a color that matches the pen's ink. The letter denotes the media intended for the pen ("P" for paper; "T" for transparency pens, which are also available). The number specifies, in tenths of millimetres, the approximate width of the line that the pen will draw.

The plotter paper provided is designed to provide clear line definition and minimize distortion, skipping, and pen "bleeding." A 24-hour recording paper is also available (see Appendix D), and can be used to further reduce bleeding when plotting direct recordings of extended duration.

Plots can also be produced on transparency film using HP transparency pens, although a pen speed slower than that used for front-panel plotting

Choosing the Correct Pen and Medium

applications is required. Slower pen speeds are achieved by issuing the HP 7090 a VS instruction via the HP-IB interface — refer to the Interfacing and Programming Manual.

Loading Pens and the Carousel

The following procedure describes how to load pens into the carousel and how to load the carousel into the HP 7090:

1. Select the pen colors to be loaded into the carousel. The following table lists suggested pen colors, although any combination may be used.

Keep in mind that, when plotting buffered data, the HP 7090 automatically selects pens 1, 2, and 3 to plot Channels 1, 2, and 3, respectively. You must manually select any of the pens loaded in the carousel for plotting direct recordings, drawing grids, and labeling measurements.

Suggested Pen Colors and Carousel Positions

Carousel Pen Number	Pen Color and Type	Example Application
1	Blue P.3	Plotting Channel 1
2	Green P.3	Plotting Channel 2
3	Red P.3	Plotting Channel 3
4	Gold P.3	Drawing Grids
5	Black P.3	Labeling
6	Brown P.3	Miscellaneous

Loading the Pens and Carousel

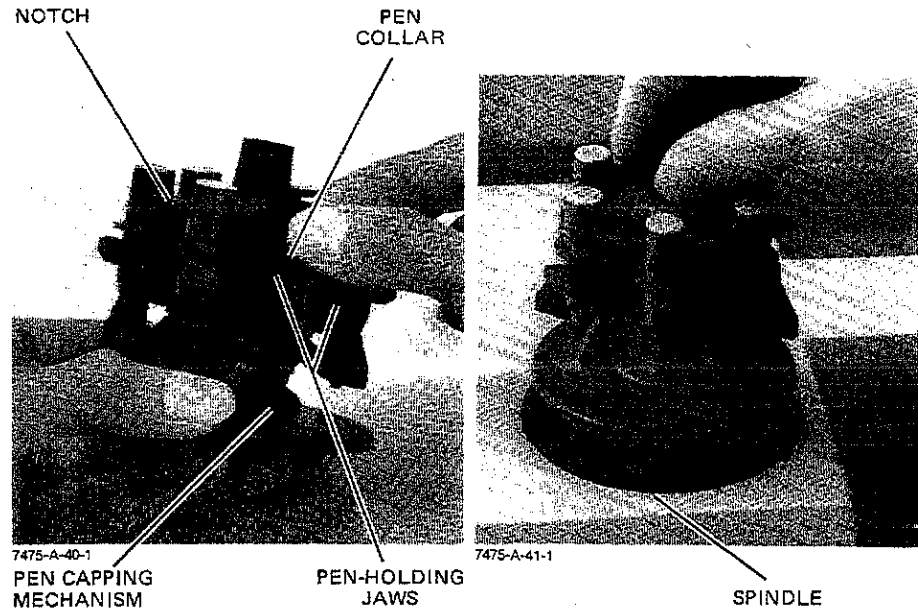

2. Uncap and load each pen into the carousel as follows. Refer to the preceding photographs.
 - a. Hold the carousel and depress the spring-loaded pen-capping mechanism.
 - b. Position the collar of the pen just below the rounded notch on the carousel and slide the pen straight into the pen-holding jaws.

- c. Release the pen-capping mechanism. The pen should be held in place and the pen cap should cover the pen's writing tip.
3. Place the carousel on the spindle located in the carousel receptacle. Rotate the carousel until it drops into position on the spindle (no force is necessary).

The paper-format switch located on the rear panel is used to set the HP 7090 for using English (ANSI) or metric (ISO) paper sizes. Set the switch to the position that corresponds with the paper sizes you intend to use. Refer to the diagram below.

Setting the Paper-Format Switch

NOTE: The position of the paper-format switch is checked by the HP 7090 only when the power is initially turned on. If you need to change paper format, turn the power on after changing the switch setting. ■

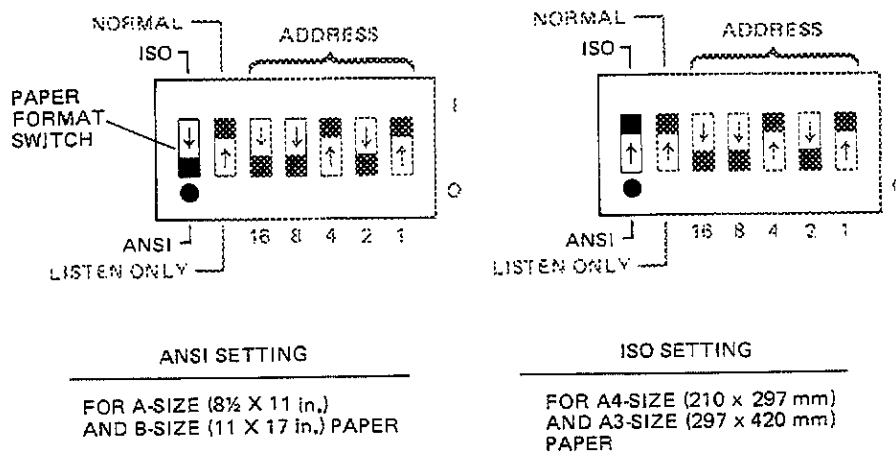

Paper-Format Switch Settings

The HP 7090 performs a set of self-tests and an initialization cycle when ac power is applied. The initialization cycle sets all front-panel setup values and modes to their default conditions (conditions assumed by the HP 7090 in the absence of alternative selections). Apply power to the instrument as follows:

Power-up Initialization/Self-Testing

1. Using the power cord supplied, connect the HP 7090 to a grounded (three-wire) ac outlet.

CAUTION

To prevent damage, ensure your HP 7090 is properly configured for the line voltage in your area. Refer to Chapter 1 of this manual.

2. Set the ~LINE power switch to ON. The HP 7090 will perform power-up initialization and self-testing, during which the following are visible on the front-panel:
 - a. The LCD displays "HP," then "7090."
 - b. All LED indicators and the LCD annotations turn on momentarily.

- c. Default conditions are established. (For a complete list of default conditions, refer to Appendix A.)

If a fault is diagnosed by the HP 7090 during the self-test procedure, the LCD will display an error code, appearing as "E", followed by a number. Should this occur, do not attempt to operate the instrument — notify your HP Sales and Support Office.

Following power-up initialization, the LCD displays "10.00 VOLTS" (the default voltage range for Channel 1), and the paper size last used. In addition, front-panel indicators are lit for the **RANGE 1** menu selection, manual trigger mode, and **CHAN 1** versus **TIME** channel selections.

Loading the Plotting Medium

To load paper (or transparency film), proceed as follows:

1. Check that the right pinch wheel is properly positioned for the paper format being used. Refer to the following illustrations.

NOTE: If necessary, snap the spacer off the shaft, slide the pinch wheel to the proper position, and snap the spacer back onto the shaft. ■

Pinch Wheel Positions

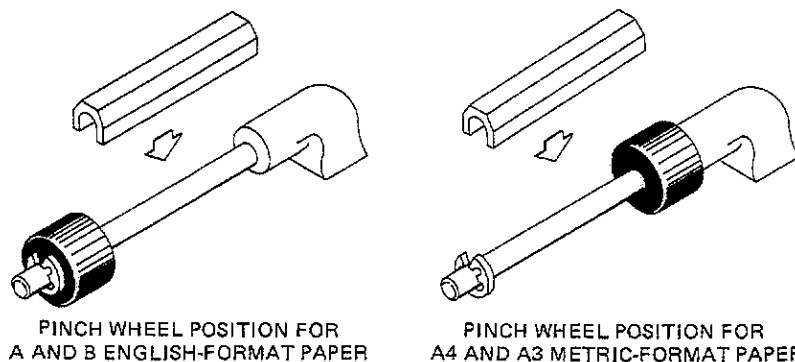

2. Ensure that the paper loading lever is in the raised position — this position raises the pinch wheels, allowing insertion of the plotting media.
3. Use the **PAPER SIZE** pushbutton to select the paper size you intend to use. For the **ANSI** paper-format switch setting, the LCD will display "8.5 × 11" or "11 × 17," depending on the paper size selection. For the **ISO** paper-format switch setting, "A3" or "A4" will be displayed.
4. Lay a sheet of the selected paper on the platen surface so the paper is aligned with the paper guide (the white line at the left rear of the platen) and the left edge of the platen. A- and A4-size paper are loaded with the long side horizontal. B- and A3-size paper are loaded with the long side vertical. Refer to the following illustrations.
5. Lower the paper loading lever to lower the pinch wheels. The drive wheel will retract the paper, then return it to the starting position. (If the paper is ejected from the rear of the platen, check to see if the paper-size selection displayed on the LCD is different than the paper size you are using.)

CAUTION

To prevent injury, keep hands, hair, and clothing away from the paper-moving mechanism and pen holder path when loading paper or performing plotting functions.

Loading A/A4-Size Paper

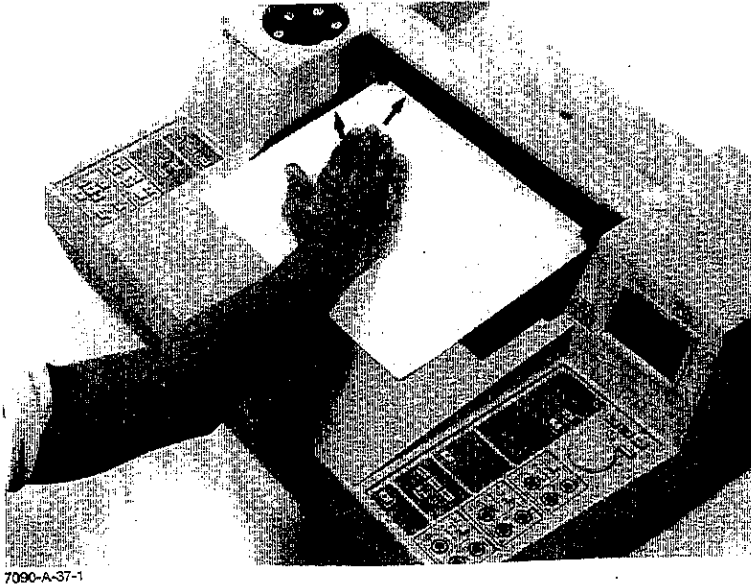

Loading B/A3-Size Paper

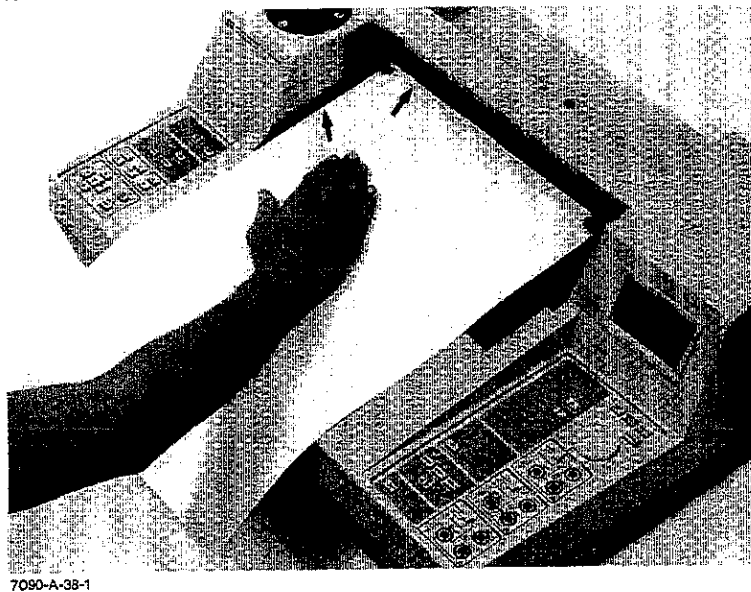

The HP 7090 has a built-in demonstration plot that can be invoked using the front-panel controls. Satisfactory execution of the plot, along with successful completion of the power-up self-test routine, serves as a confidence test, indicating a high probability that the HP 7090 is functioning properly.

The Demonstration Plot/Confidence Test

The demonstration plot will run on any size paper. However, because the plot is preformatted to run on A- or A4-size paper, the plot will fill only half a sheet of B- or A3-size paper. Before performing the demonstration plot, make sure the pens, carousel, and paper have been loaded properly. To start the plot, hold down the ◀ and ▶ CURSOR CONTROL pushbuttons and press SHIFT.

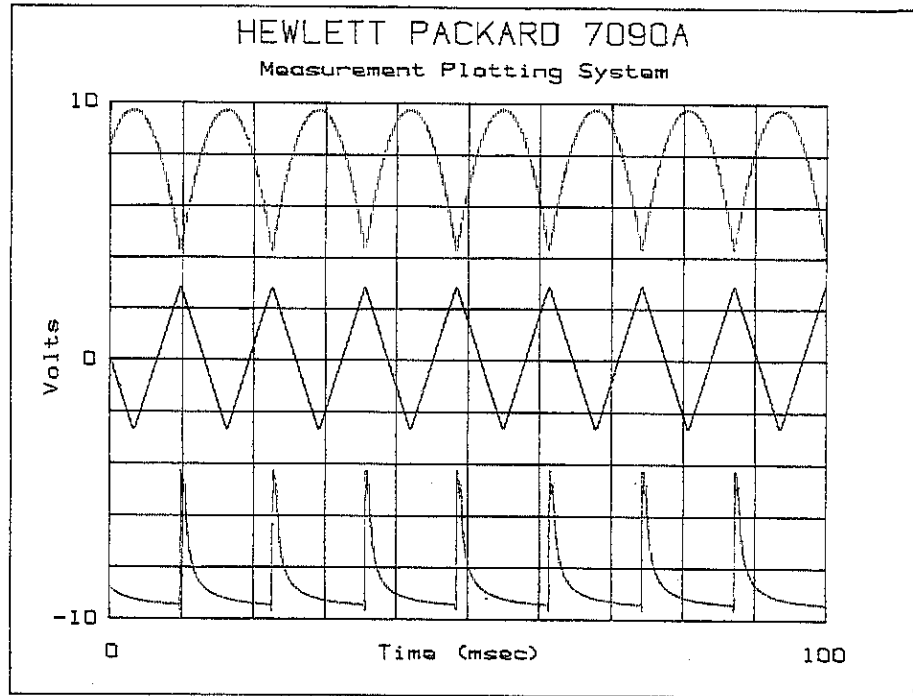

Using the Front-Panel Controls

Most of the front-panel controls perform specific tasks that are described in appropriate sections of this manual. Several of the controls, however, may be used for various purposes during measurement or plotting procedures. This section describes these “general purpose” controls.

The Shift Pushbutton



The blue **SHIFT** pushbutton is used to access the shift functions of dual-function pushbuttons. (Shift functions are labeled in blue directly below pushbuttons.) To access a shift function:

1. Display “SHIFT” on the LCD by using the **SHIFT** pushbutton. The pushbutton toggles between on (“SHIFT” displayed) and off (“SHIFT” not displayed).
2. Press the desired shift function pushbutton. The “SHIFT” display is extinguished and the selected function is performed.

NOTE: Once activated, the “SHIFT” display remains on until a shift function is invoked, or until **SHIFT** is pressed a second time. Because the “SHIFT” display indicates which function will be performed when a dual-function pushbutton is pressed, always check the display before using a dual-function pushbutton. ■

The Stop/Initialize Pushbutton

The **STOP** pushbutton is used to terminate functions before they are finished, whereas **INIT** (secondary function) is used to initialize the HP 7090 to all default conditions. These functions are described separately below.



Stopping Measurement/Plotting Functions

At times you may want to stop a function before it is completed. This can be accomplished by pressing **STOP**. The following functions can be terminated (or modes, exited) by pressing the **STOP** pushbutton:

- Direct recording.
- Buffered recording (of 5-second duration or more).
- Plotting of buffer contents.
- Drawing of grids.
- Data-display mode (exited).
- Data-streaming (following the receipt of a QD instruction via the I/O interface).

Labeling functions cannot be terminated using the **STOP** pushbutton — once a label function has been invoked it is drawn through completion.

Initializing the HP 7090

The default conditions assumed by the HP 7090 during power-up can also be attained by pressing (**SHIFT**) **INIT**. This *front-panel initialization* procedure restores all power-up default conditions to the instrument. (A complete listing of all default conditions is provided in Appendix A of this manual.)

NOTE: Performing a front-panel initialization erases the current measurement data stored in the buffers. If you intend to plot the current buffer contents, do so before initializing (or powering down) the HP 7090. ■

The Restore Setup/Save Setup Pushbutton

The **RESTORE SETUP/SAVE SETUP** is used to save an established set of front-panel setup conditions and parameters in nonvolatile memory, and to later restore the saved set of conditions.



The currently selected setup condition values, along with other conditions specified using front-panel controls, may be saved in the HP 7090's nonvolatile memory. These values and conditions may then be restored when needed. This feature enables you to save a complete front-panel setup when the instrument's power is turned off, or while alternative setup conditions are selected.

To save a front-panel setup, press (**SHIFT**) **SAVE SETUP**. If a set of conditions is already stored in nonvolatile memory, the current set of conditions will

replace the old set. The following setup conditions and specifications are saved (the items listed are detailed in appropriate sections of this manual).

- RANGE 1, RANGE 2, RANGE 3.
- OFFSET 1, OFFSET 2, OFFSET 3.
- GRID DIVISIONS/X-AXIS, GRID DIVISIONS/Y-AXIS.
- TOTAL TIME.
- POST-TRIGGER or PRE-TRIGGER time.
- TRIGGER LEVEL.
- TRIGGER WIDTH.
- Trigger mode selection.
- CHANNEL SELECT selections.
- Locations of the zero and full-scale points.
- Locations of the P1 and P2 scaling points.
- Quadrants selected for receiving a grid.
- Rotation of the recording area.

To restore a setup that has been saved, press **RESTORE SETUP**. The saved setup conditions and specifications will replace those currently selected. Restoring a saved setup does not remove it from memory — the setup is saved until a new set of values is stored.

NOTE: The nonvolatile memory (EEPROM) used to save setups is limited to approximately 10,000 “save cycles.” Although the EEPROM is replaceable, the save setup function should be used selectively. ■

The Setup Conditions Menu Controls

Values used to specify various measurement and plotting parameters are established with the **SETUP CONDITIONS** menu and controls, shown by the following illustration. Setup condition values determine such things as recording time, input-voltage range, and trigger voltages.

The setup condition selectors are used to move through the setup condition choices — briefly pressing a selector accesses individual menu items in sequence, and the currently selected item is shown by the appropriate menu indicator. Holding a selector down enables you to move through the selections quickly.

Selecting a setup condition displays its current value on the LCD. Although the setup conditions are initialized to their default values following power-up, you can modify any of the default values by using your fingertip to rotate the control wheel. Rotating the control wheel clockwise increments the displayed value (within an established range); counterclockwise rotation decrements the value. For each condition you wish to modify, turn the control wheel until the desired value is displayed — this value automatically becomes the new, current value for the selected setup condition.

Selected setup condition values are effective until 1) new values are specified using the control wheel, 2) a front-panel initialization is performed, 3) the power is turned off, or 4) a saved setup is restored (as described in the next section of this manual).

A “coarse-tuning” function is provided that permits rapid access of desired setup condition values. Pressing the **COARSE** pushbutton enables this function, indicated by “COARSE” displayed on the LCD. While the coarse-tuning function is in effect, turning the control wheel generally accesses every tenth selectable value. When the approximate intended value has

Setup Conditions Menu and Controls

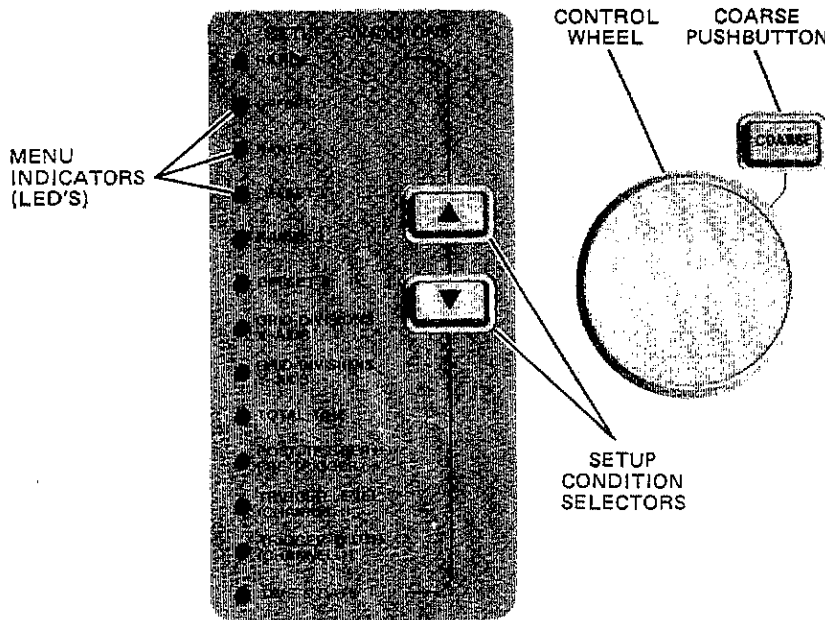

been displayed, press the **COARSE** pushbutton a second time to exit the coarse-tuning function (and extinguish the "COARSE" display). The control wheel can then be used to fine-tune setup condition values.

Some of the measurement and plotting functions performed by the HP 7090 require the selection and positioning of pens. Pen control is accomplished from the front panel by using the controls described in the following paragraphs.

Pen Selection Controls

When plotting direct recordings, drawing grids, or printing labels, you will need to select the pen(s) of your choice by using the **PEN SELECT** pushbuttons. The pushbuttons are numbered 1 through 6; these numbers correspond to the positions of the pens in the carousel.

The Pen Controls

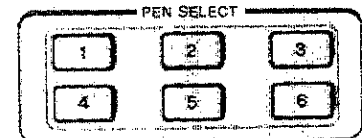

To select a pen, press one of the **PEN SELECT** pushbuttons. The pen holder will move from its present position to the carousel, which rotates until the selected pen is accessible by the pen holder. The pen holder then retrieves the pen and returns to its previous position.

The first pen selection made following power-up causes the carousel to rotate to a standard orientation so that correct pen selections will be made. (The tapping noise heard during this initial rotation is normal, and is caused by the carousel-advance mechanism.)

If a pen selection is made when the pen holder is already holding a pen, the holder stores its current pen before retrieving the newly selected one. Try pressing some **PEN SELECT** pushbuttons to familiarize yourself with the pen-select function.

When not using the HP 7090, the currently selected pen should be returned to the carousel to prevent ink evaporation. To store the last pen, press **SHIFT**

(to display "SHIFT"), then press the **PEN SELECT** pushbutton that corresponds to the current pen. The pen holder will put the pen away. The pen holder also returns the current pen to the carousel when the paper loading lever is raised for removing paper.

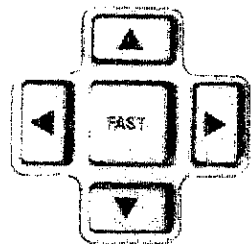

The Pen Cursor Controls

The pen cursor controls are used to manually position the current pen within the writing area of the paper. Pressing a cursor control moves the pen in the direction of the control arrow; pressing adjacent controls moves the pen at a 45-degree diagonal between the two arrow directions. When the central **FAST** pushbutton is pressed in conjunction with any cursor control(s), the pen-positioning speed is increased.

The Pen Up and Pen Down Pushbuttons

The pen may be raised or lowered by pressing the **PEN UP** or **PEN DN** pushbuttons, respectively. These pushbuttons can be used to raise or lower pens during plotting, mark reference points on the medium and, when used in conjunction with the pen cursor controls, draw lines or accentuate the X- or Y-axes of grids.

After performing any front-panel function, the pen is automatically raised to prevent the bleeding of ink onto paper. In addition, if **PEN DN** is pressed to latch the pen in the "down" position and the pen is allowed to remain motionless for approximately 65 seconds, the HP 7090 will raise the pen.

Setting the Real-Time Clock

The internal, real-time clock used to time recording functions and annotate time labels is preset at the factory using Pacific Standard Time. Because the clock is battery powered, it will maintain correct time even when the HP 7090 is turned off. However, time-zone changes may necessitate changing the clock settings.

To set the real-time clock:

1. While holding down the **SHIFT** pushbutton, use the ▼ setup condition selector to select the **TIME AND DATE** selection. (The **TIME AND DATE** indicator will remain lit while the clock-setting function is in effect. The function is exited whenever the ▲ selector is pressed.)

The LCD will display a two-digit number representing the current year selection, along with the word "YEAR."

2. If you need to change the year selection, turn the control wheel until the desired value is displayed. The selected value is automatically entered.
3. Press the ▼ setup condition selector to display the current month selection, along with the word "MONTH." Use the control wheel if you need to change the month selection.
4. Press the ▼ selector to display and select values for the day ("DAY" is displayed), then hours (24-hour notation is used and "HOURS" is displayed).
5. Press the ▼ selector to display the current minute selection and "MINUTES." When a new minute value is selected using the control wheel, the selected minute value is entered, the value for seconds is

automatically set to zero, and the clock begins running using all of the newly selected values.

6. Press the ▼ selector. The LCD will display the current hours and minutes, along with "HOURS.MINUTES." The decimal point flashes at one-second intervals to indicate the clock is running. (The control wheel has no effect on the hours-minutes display.)
7. Press the ▼ selector. The LCD will display the current minutes and seconds, along with "MINUTES.SECONDS." (The control wheel has no effect on the minutes-seconds display.)
8. Press the ▼ or ▲ selector to exit the clock-setting function. The menu selection will return to **RANGE 1**.

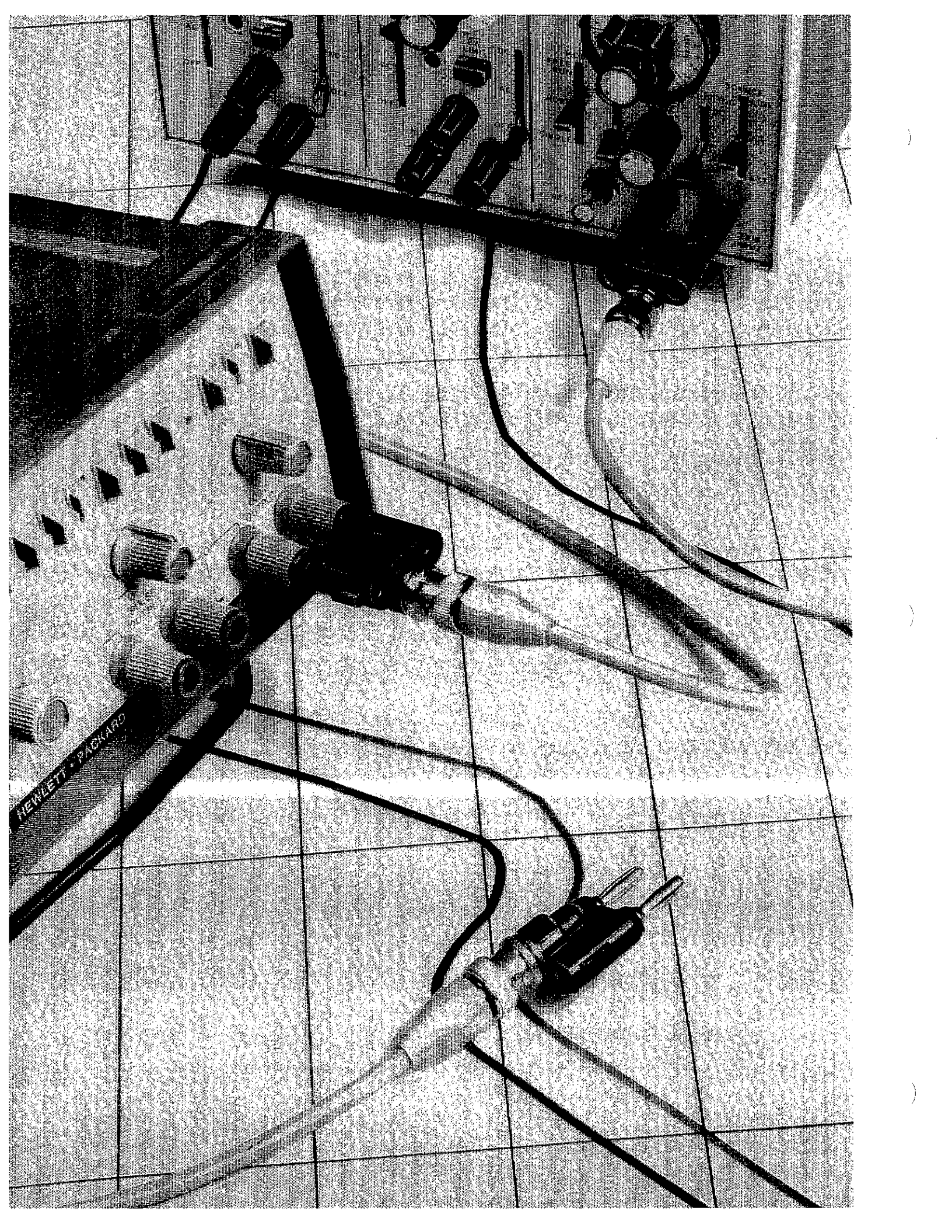

Chapter 3

Measurement Setup Operations

Before performing a measurement on the HP 7090, several front-panel operations are necessary. Most of these operations involve specifying setup conditions appropriate for your measurement application. For example, **TOTAL TIME** is used to establish the recording time; the **RANGE** setting(s) are used to match the sensitivity and range of the HP 7090 to the input signal(s). Front-panel operations can also be used to draw a scaled grid to receive the measurement plot.

This chapter describes how to perform these measurement setup operations. Information is also provided on how to connect analog input signals to the HP 7090. After you become familiar with the material presented here, you will be ready to perform the direct and buffered recording procedures discussed in Chapter Four.

The Recording Area

The direct and buffered recording modes can be used to produce hardcopy plots of input signal data. Data is plotted or "mapped" onto a specified area of the paper — a rectangular coordinate system called the *recording area*.

The following illustration shows a hardcopy plot of a Channel 1 input signal measured against time. The recording area is the area covered by the grid. (The axes labels shown in this and subsequent illustrations were not achieved using front-panel operations. Labeling of the axes can be accomplished, however, by issuing instructions to the HP 7090 via an HP-IB interface. Refer to the Interfacing and Programming Manual.)

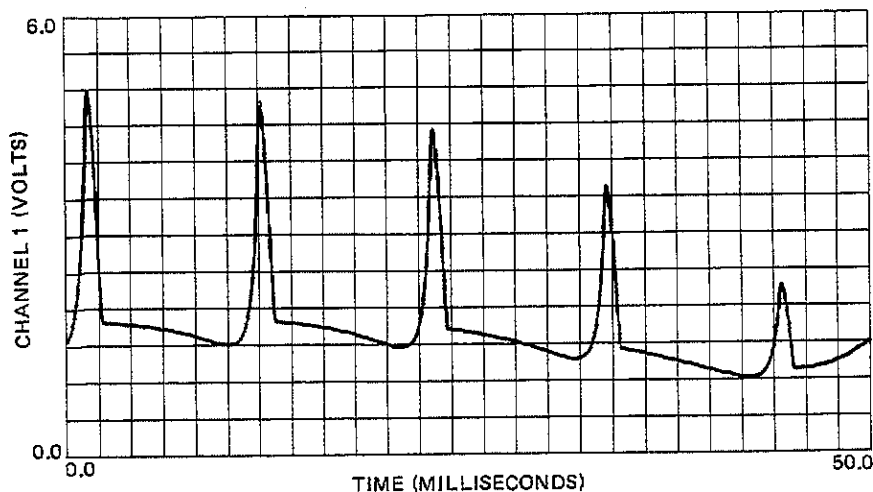

*A Recording Area
and Plotted Data*

Before plotting a measurement, a recording area should be prepared that is appropriate for the application. Preparing a recording area accomplishes several tasks — it defines the axes, boundaries, and scaling of the coordinate system; matches the sensitivity and range of the HP 7090 to the input signal voltage(s); and establishes the recording time.

The procedures involved in preparing a recording area can be grouped into the following four steps:

1. **Defining the axes.** The X- and Y-axes are defined using the **CHANNEL SELECT** pushbuttons. For the preceding illustration, **CHAN 1** was selected for the Y-axis; **TOTAL TIME** was selected for the X-axis.
2. **Establishing the recording area boundaries.** The coordinate system quadrants required for plotting are determined and the location and size (boundaries) of the recording area are specified on the plotter paper by positioning the zero and full-scale points.

Because the Channel 1 input signal used for the illustration consisted of positive voltages, only Quadrant I (positive Y-axis values and positive X-axis values) was required. The actual area intended for the quadrant was then established on the plotter paper.

3. **Scaling the recording area boundaries.** The scaling (limits) of the X- and Y-axes is defined by specifying appropriate setup condition values.

In the example, **RANGE 1** was set at 6.0 volts to scale the Y-axis (Channel 1 input) to 0.0–6.0 volts. **TOTAL TIME** was set to 50.0 milliseconds to scale the X-axis (time) to 0.0–50.0 milliseconds.

4. **Scaling and drawing the recording area grid.** The scaling for the grid divisions is selected using the **GRID DIVISION** setup conditions, and the grid is drawn. For the example, each Y-axis grid division represents 0.5 volt; each X-axis grid division represents 2.0 milliseconds.

The following four sections detail how to perform the four steps outlined above. Although the steps can be performed in other sequences, the order given here permits a logical presentation of the material. With the information in these sections, you will be able to design a suitable recording area for nearly any measurement application.

Defining the Axes/Channel Selection (Preparing the Recording Area: Step 1)

Measurements made using the HP 7090 may be classified as *versus-time* or *versus-chan3*, depending upon the assignment of the X-axis variable. For *versus-time* measurements, time is assigned to the X-axis; the Y-axis is reserved for the channel input signal(s). For *versus-chan3* measurements, the Channel 3 input signal is assigned to the X-axis, and Channel 1 and/or 2 is assigned to the Y-axis. The following figure shows the axes defined for both measurement types.

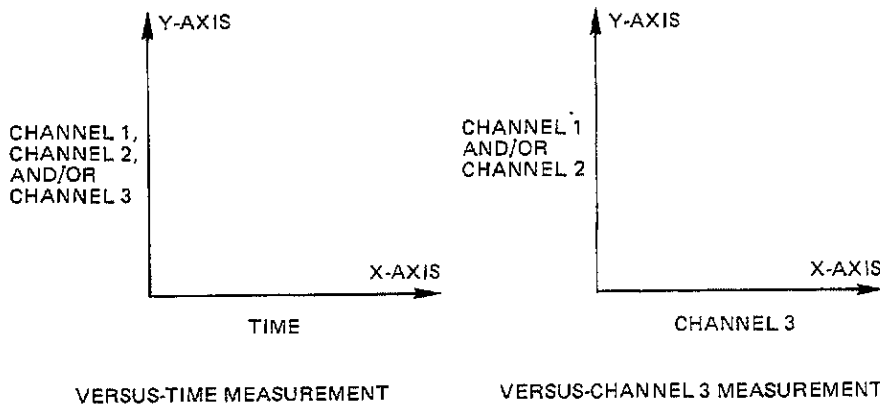

The variables to be used for plotting are selected using the **CHANNEL SELECT** pushbuttons shown by the following illustration. The lower pushbutton toggles between the X-axis selections. **TIME** (for versus-time measurements) or **CHANNEL 3** (for versus-chan3 measurements) may be selected. The current selection is shown by the indicator that is lit.

The three upper **CHANNEL SELECT** indicators and pushbuttons (labeled **CHAN 1**, **CHAN 2**, and **CHAN 3**) are used to select the Y-axis variable(s). Each pushbutton toggles between "on" and "off." If none of the channels are selected (all indicators turned off), **CHAN 1** is automatically selected by the HP 7090. In addition, if Channel 3 is selected for the X-axis variable, it is not selectable for the Y-axis.

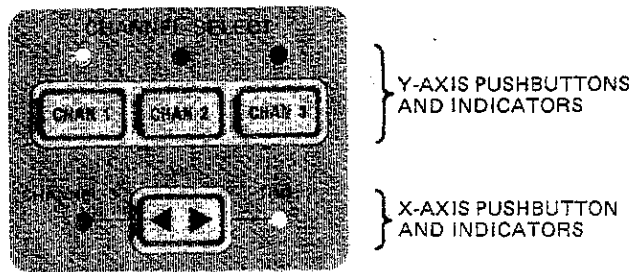

The Channel Select Controls

For the direct recording mode, channel selections must be made before you initiate the recording. Because real-time plots are drawn during a direct recording, only one Y-axis variable may be plotted during a single recording — if more than one selection is made for the Y-axis, only the lowest-numbered selection will be plotted.

During a buffered recording, all three channel buffers are filled before the data is plotted (regardless of the channel selections). After input data has been stored in the buffers, any or all of the channels (buffers) may be selected for plotting along the Y-axis. If more than one Y-axis variable is selected for a buffered recording plot, the HP 7090 will plot selections sequentially starting with the lowest-numbered selection.

Establishing the Recording Area Boundaries (Preparing the Recording Area: Step 2)

After deciding which variables are to be plotted, the portion of the paper to receive the plot is established by specifying the locations of two movable points, *zero* and *full scale*, which determine the boundaries of the recording area. Following power-up or front-panel initialization, these points are located at their default positions near opposite corners of the plotter paper, but you can reposition them to set the dimensions and locations of your hardcopy plots.

The following illustration shows the zero and full-scale points positioned on a sheet of A-size paper. The full-scale point is located near its default position, and the zero point has been positioned near the center of the paper. The zero point is used to mark the origin of the recording area coordinate system. The full-scale point marks the upper X- and Y-axis limits of the recording area, and may be expressed in X,Y coordinates as (FS_x, FS_y) . Note that the zero and full-scale points establish Quadrants I, II, III, and IV of the recording area.

A Recording Area

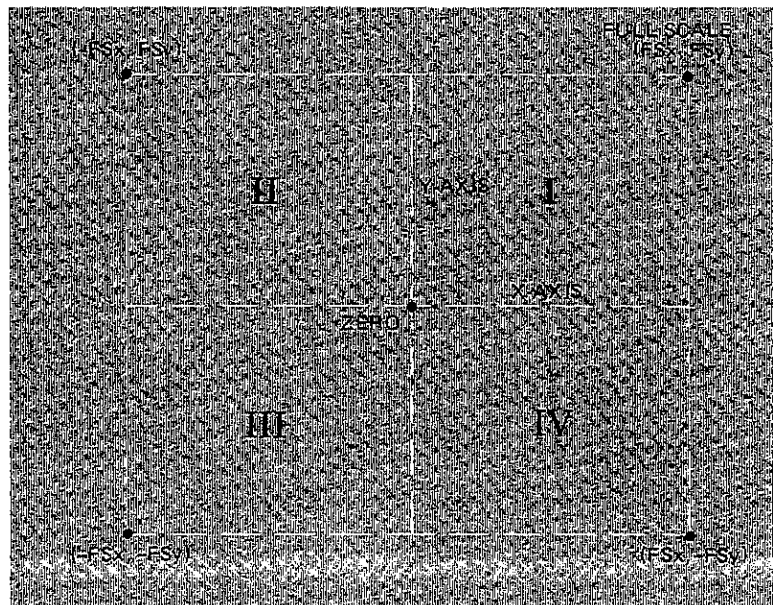

If the recording area shown in the preceding illustration was used for plotting a Channel 1 vs Channel 3 measurement, for example, the zero point would be the intersection of 0.0 volts (X-axis, Channel 3 input) and 0.0 volts (Y-axis, Channel 1 input). Similarly, the full-scale point would be the intersection of the X-axis, full-scale voltage (**RANGE 3**) and the Y-axis, full-scale voltage (**RANGE 1**). Other data points would be mapped onto the appropriate recording area quadrants.

Clipping

A recording area can normally be defined that will contain all the data points measured by the HP 7090 during an individual recording session. However, the boundaries of the recording area are limited by the size of the paper used and by the paper-moving mechanism. These imposed limits are defined as the *hard-clip limits*. The hard-clip limits determine the limits of pen motion and the area within which the zero and full-scale points can be

positioned. When designing a recording area, care must be taken that the required areas of the coordinate system do not exceed the hard-clip limits; otherwise data will be "clipped" when plotted.

An example of clipping is demonstrated by the following illustration. The upper figure shows a recording area (white) defined by the zero and full-scale points. Note that the points have been positioned so that all coordinate system quadrants are within the hard-clip limits (dotted lines). Such a recording area might be prepared for plotting a versus- chan3 measurement having negative X- and Y-axis data.

In the lower figure, the zero and full-scale points have been moved so that Quadrants II, III, and IV intersect the hard-clip limits. Because the pen cannot move beyond the hard-clip limits when plotting measurements, data points that would normally be mapped onto the deleted regions of the recording area would be clipped at the limits and excluded from the plot.

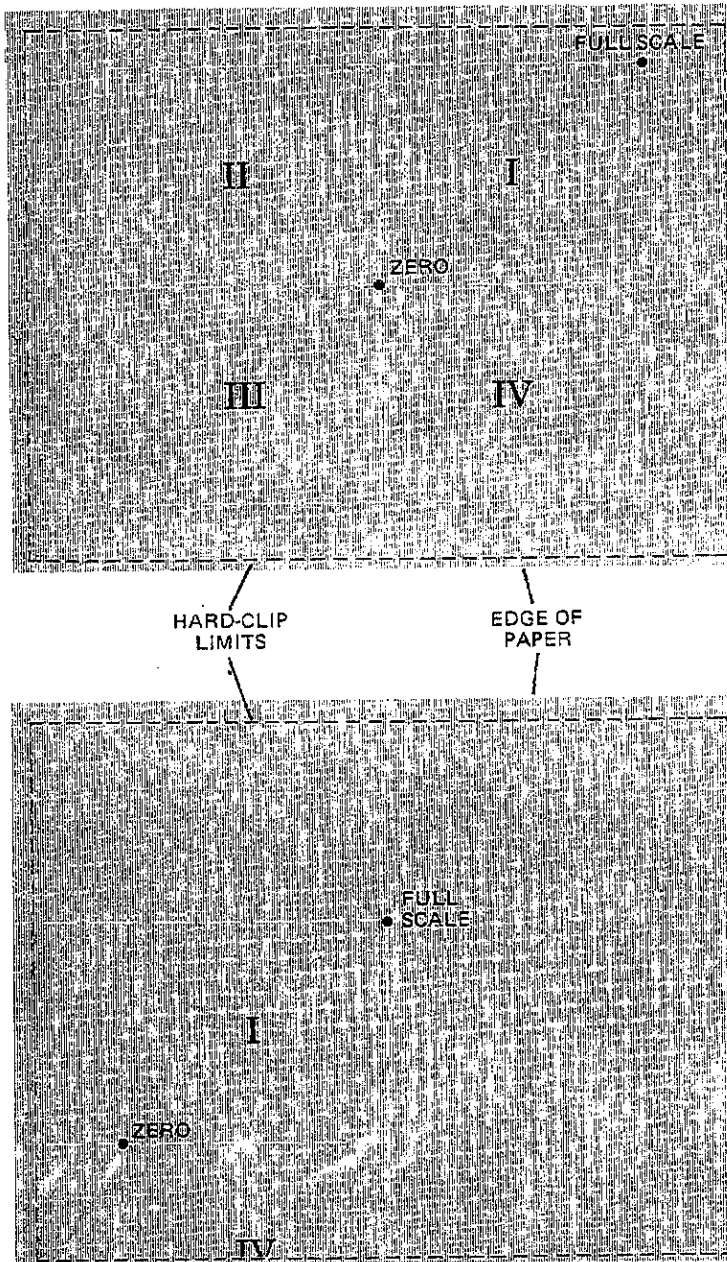

Clipping at the Hard-Clip Limits

Because time is always plotted in the positive X-axis direction on the HP 7090, clipping of Quadrants II and III need be of no concern when preparing recording areas for versus-time measurements. (For the recording areas described and illustrated in the remainder of this manual, assume that the zero and full-scale points have been positioned so clipping of the required quadrants or data points does not occur.)

Positioning the Zero and Full-Scale Points

The zero and full-scale points are located at their default positions following power-up or front-panel initialization. For A/A4-size paper, the zero point is located on the lower-left corner of the paper and the full-scale point is located on the upper-right, as the following illustration shows. The resulting coordinate system is oriented so that the X-axis is parallel to the long axis of the paper. Similarly, for B/A3-size paper, the coordinate system is oriented so that the X-axis is parallel to the paper's long axis.

Default Locations of Zero and Full Scale (A/A4 Paper)

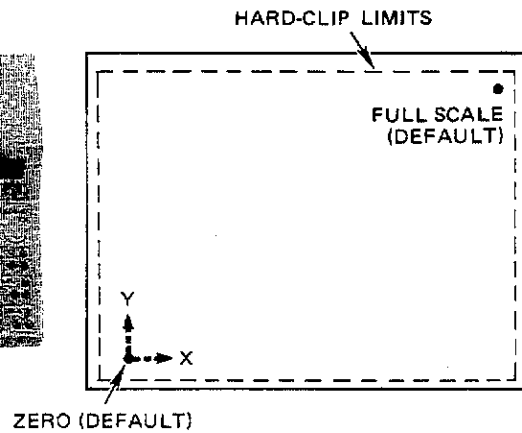
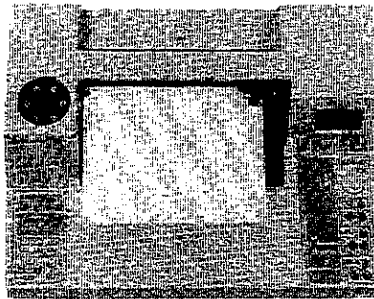

Default Locations of Zero and Full Scale (B/A3 Paper)

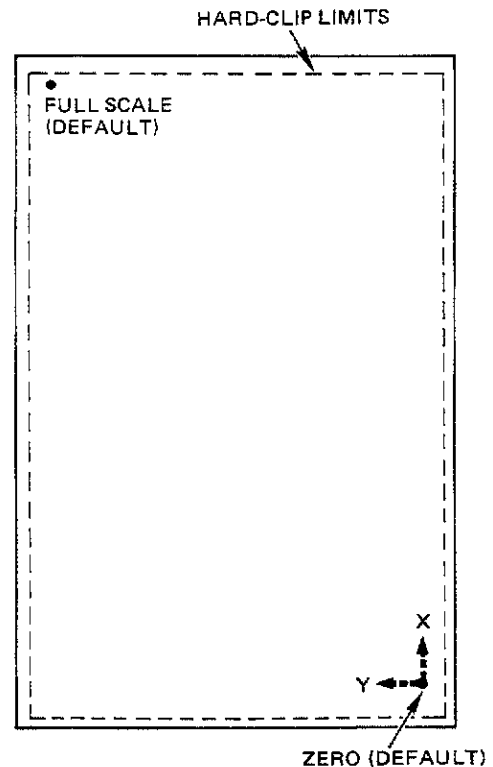
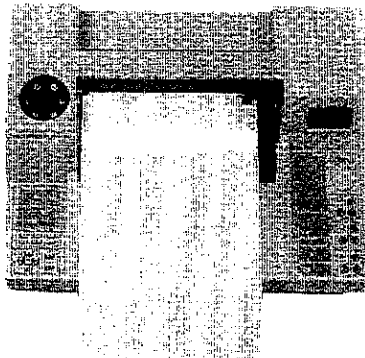

To determine the exact default location of the zero point, load the HP 7090 with paper, press (SHIFT) INIT to initialize the instrument, select a pen, and press the ZERO pushbutton. This invokes the zero-point positioning function and moves the pen above the current zero point. The ZERO indicator lights, indicating that the zero-point positioning function is in effect. Similarly, pressing the FULL SCALE pushbutton invokes the full-scale positioning function and places the pen above the current full-scale point. The FULL SCALE indicator lights to show the function is in effect.

To reposition the zero point when you are preparing a recording area, follow the steps shown in the following illustration.

Positioning the Zero Point

1. Press ZERO to invoke the zero-positioning function (ZERO indicator on).

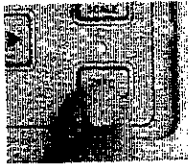

2. Use the pen cursor controls to move the pen to the desired zero point.

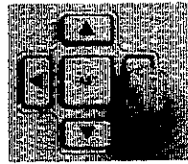

3. Press ZERO a second time to enter the new zero position and exit the positioning function (ZERO indicator off).

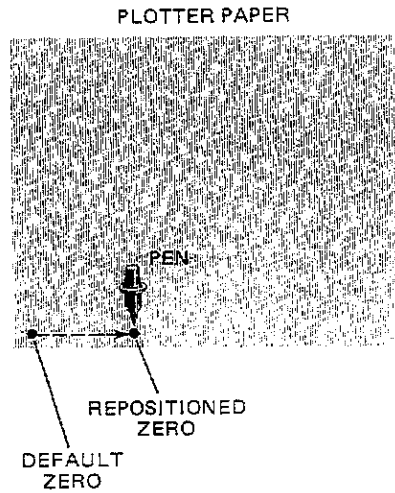
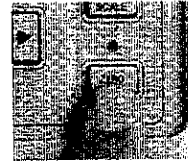

NOTE: Always exit the zero-point positioning function to prevent accidental repositioning of the zero point. ■

The full-scale point is positioned in a manner similar to that illustrated for the zero point. To position the full-scale point when preparing a recording area:

1. Press **FULL SCALE** to invoke the full-scale positioning function (**FULL SCALE** indicator on).
2. Use the pen cursor pushbuttons to move the pen to the desired full-scale point (upper-right corner of the coordinate system).
3. Press **FULL SCALE** a second time to enter the new full-scale position and exit the full-scale positioning function (**FULL SCALE** indicator off).

NOTE: Always exit the full-scale positioning function to prevent accidental repositioning of the full-scale point. ■

When you position the zero point, the full-scale point is automatically moved (within the hard-clip limits) with the zero point so their relative locations are maintained. This feature allows you to create equal-sized plots by moving only the zero point. Because of the simultaneous movement, the zero point should always be positioned before positioning the full-scale point.

The full-scale point should always be located above and to the right of the zero point (when viewing the recording area with the positive X-axis extending to your right). If the zero and full-scale points are not positioned in this manner, subsequent plots will be improperly oriented.

Scaling the Recording Area Boundaries (Preparing the Recording Area: Step 3)

Before performing a direct or buffered recording, the duration of the recording is specified using the **TOTAL TIME** setup condition. In addition, the channel input range(s) of the HP 7090 is established using the channel **RANGE** and **OFFSET** setup conditions.

These setup conditions not only determine the physical boundaries of the recording, they also determine the scaling of the recording area prepared to receive the data plot. The **TOTAL TIME** setup condition establishes the scaling of the X-axis for versus-time measurements, and the channel **RANGE** and **OFFSET** setup conditions establish the scaling of the Y-axis. (For versus-chan3 measurements, the Channel 3 **RANGE** and **OFFSET** conditions determine the X-axis scaling.)

The Total Time Setup Condition

Default Value: 1.0 second.

Range of Selectable Values: 0.03 second to 24 hours. (For direct recordings, **TOTAL TIME** settings of less than 1.0 second are automatically defaulted to 1.0 second when the recording is initiated.)

Measurement recording time is determined by the **TOTAL TIME** setting. For buffered recordings, **TOTAL TIME** designates the time required for the buffers to fill. For direct recordings, **TOTAL TIME** determines the actual plotting time. (Recording time and plotting time are synonymous for the direct recording mode.)

NOTE: For versus-chan3, manually-triggered direct recordings, the **TOTAL TIME** setting is ignored; plotting is stopped by pressing **STOP**. ■

TOTAL TIME also defines the scaling of the positive X-axis for any recording area used for plotting versus-time measurements. The diagram below shows a recording area designed for plotting a positive dc voltage against time. **TOTAL TIME** was set to obtain a recording time of 10.0 seconds. As a result the positive X-axis is scaled as shown, extending from 0.0 to 10.0 seconds.

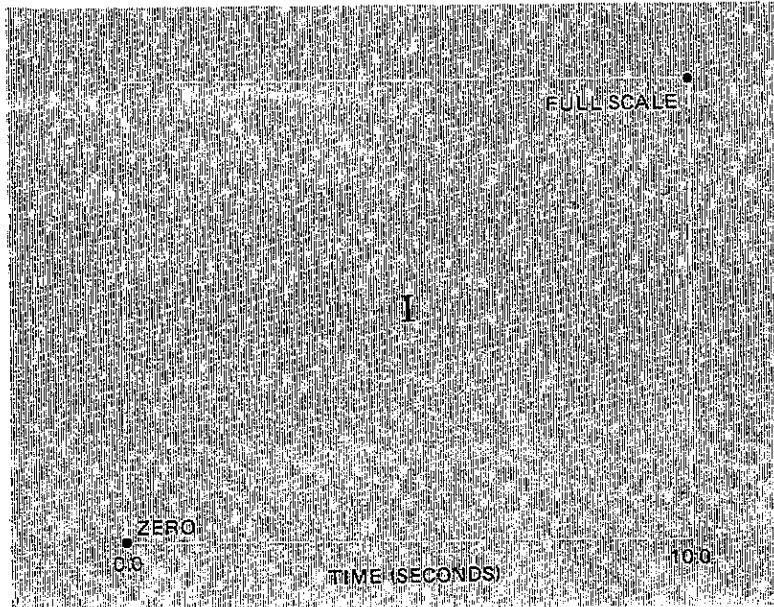

Scaling the X-Axis with Total Time

SETUP CONDITION
TOTAL TIME 10.0 SECONDS

Default Value: 10.0 volts.

Range of Selectable Values: 5.0 millivolts to 100.0 volts.

The channel range settings allow a large scope of input signal amplitudes to be accurately measured. To obtain optimum accuracy, it is often necessary to set **RANGE** in conjunction with the **OFFSET** setup condition. The effects of **RANGE** on the recording area should be thoroughly understood, however, before attempting to use offset conditions.

Setting range on the HP 7090 is effectively like setting the attenuator on a voltmeter — accuracy is obtained by choosing a range setting that is suited to the input signal amplitude. If no offset is used, range should be set equal to (or somewhat higher than) the absolute value of the largest peak voltage, positive or negative, expected from the input signal.

To demonstrate the effects of **RANGE** and **OFFSET** on recording areas, a recording area will be prepared for an example Channel 1 input signal, Signal A. For our present purposes, a recording area will be designed using **TOTAL TIME** and **RANGE 1** only. In the next subsection, which describes the **OFFSET** setup condition, the recording area will be modified to obtain optimum accuracy by using the **OFFSET** condition in conjunction with **RANGE**.

The Range Setup Condition

Values for maximum and minimum signal voltages (V_{max} and V_{min}) are given for signal A below. The largest peak voltage is $V_{max} = 5.3$ volts. A setting of 6.0 volts was used for RANGE to provide a range scale that is easy to read and interpret, and to allow some extra headroom during recording.

Determining Range Setting

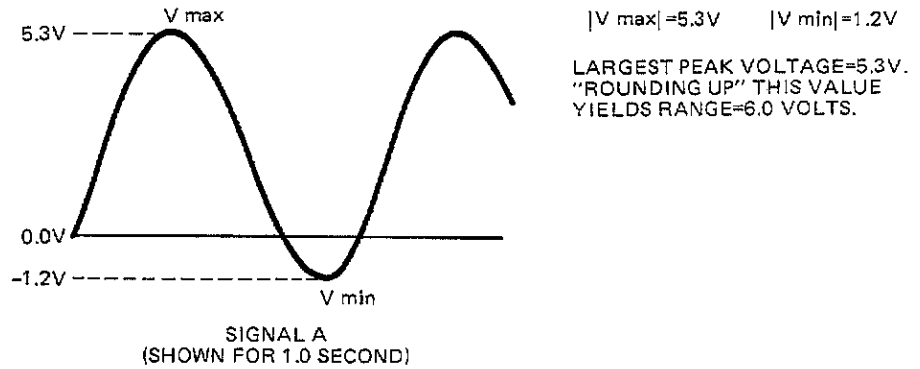

Setting the RANGE automatically scales the recording area in a manner similar to setting TOTAL TIME. For versus-time measurements, the range setting for the selected Y-axis channel designates the range of the positive Y-axis. In addition, the positive Y-axis range is “mirrored” onto the negative Y-axis.

This is illustrated by the following diagram, which shows the recording area resulting from the signal A range setting, along with the signal as it would be plotted.

NOTE: If more than one channel is selected for Y-axis plotting onto a single recording area, the scaling of the Y-axis is independently determined by each channel range setting. ■

Scaling the Y-Axis with Range

SETUP CONDITIONS	
TOTAL TIME	1.0 SECOND
RANGE1	6.0 VOLTS

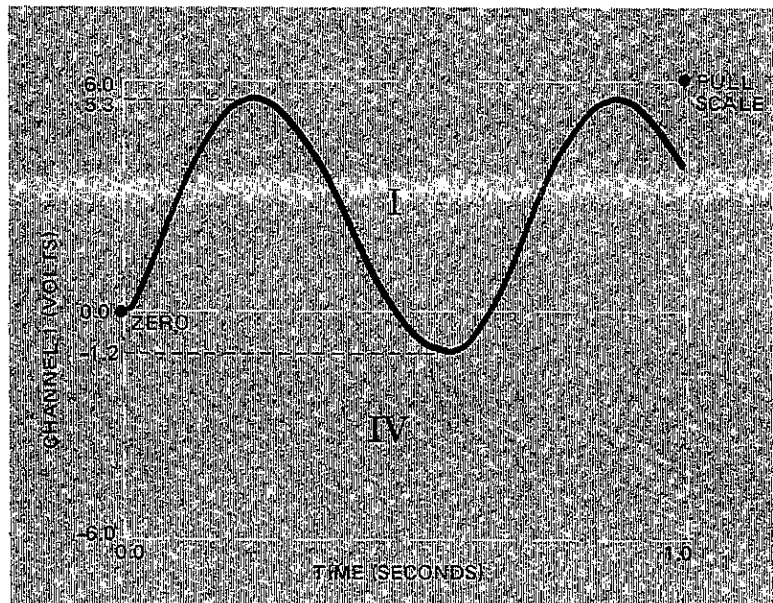

When performing a versus-chan3 plot, the X-axis scaling of the recording area is determined by the Channel 3 range setting (rather than by the total time setting). The Channel 3 range setting is mirrored onto the negative X-axis. This is shown by the following figure, which shows a recording area designed for plotting Channel 1 versus Channel 3.

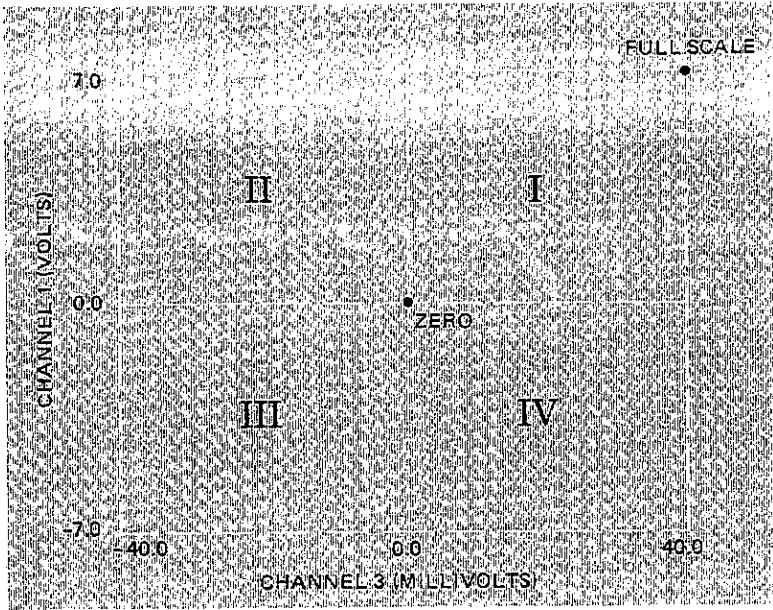

Scaling the Axes for a Versus-Chan3 Measurement

SETUP CONDITIONS (Versus-Chan3 Recording)	
RANGE 1	7.0 VOLTS
RANGE 3	40.0 MILLIVOLTS

Calculating Range Settings

Optimum accuracy of measurements for any selected input channel is obtained when the channel's **RANGE** is set at the lowest (most sensitive) value that will allow all data to be plotted without clipping. For ac signals having a median voltage V_{med} of zero, this can be achieved by setting **RANGE** equal to the peak signal amplitude (one-half the actual signal range). Signal range may be expressed as $V_{max} - V_{min}$. Hence, the ideal **RANGE** setting may be obtained by using the *range equation* below.

$$\text{RANGE} = \frac{1}{2} |V_{max} - V_{min}|$$

The following illustration demonstrates how the range setting obtained using the range equation affects the recording area. The V_{max} and V_{min} values for the illustrated signal yield a range setting of 5.0 volts. Using this setting scales the recording area as shown. Because the range setting is mirrored above and below the zero point, the entire signal is mapped onto the recording area as shown.

If a signal having a *nonzero* median voltage is recorded using a range setting (and no **OFFSET**) calculated using the range equation, an invalid measurement will result and the plotted signal will be clipped. This is demonstrated by the subsequent illustration, using signal A from previous examples. When the **RANGE** equation is applied to the V_{min} and V_{max} values for signal A and the resulting range setting of 3.25 volts is used, the recording area's Y-axis is scaled as shown. Data points for voltages above the 3.25-volt limit are clipped from the resulting plot. Clipping becomes more pronounced when median signal voltages are displaced (offset) further and further from zero volts. To obtain accuracy for such signals, the **OFFSET** setup condition should be used in conjunction with **RANGE**, as explained in the section to follow.

Plot Using the Range Equation, for $V_{med} = 0$

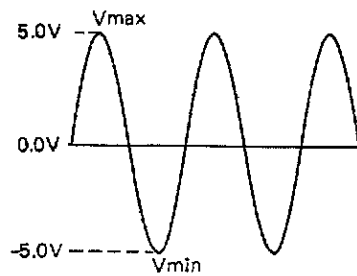

$$\begin{aligned} \text{SET RANGE} &= \frac{1}{2}|V_{max} - V_{min}| \\ &= \frac{1}{2}|5 - (-5)| \text{ VOLTS} \\ &= 5.0 \text{ VOLTS} \end{aligned}$$

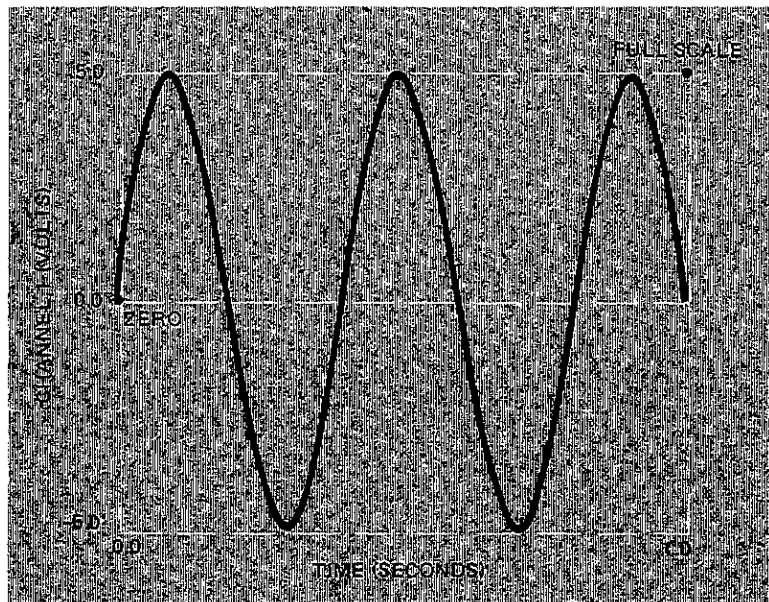

SETUP CONDITIONS	
TOTAL TIME	1.0 SECOND
RANGE 1	5.0 VOLTS

Plot Using the Range Equation, for $V_{med} \neq 0$

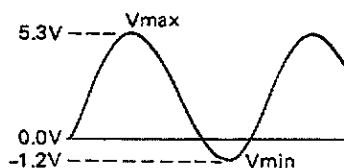

$$\begin{aligned} \text{SET RANGE} &= \frac{1}{2}|V_{max} - V_{min}| \\ &= \frac{1}{2}|5.3 - (-1.2)| \text{ VOLTS} \\ &= 3.25 \text{ VOLTS} \end{aligned}$$

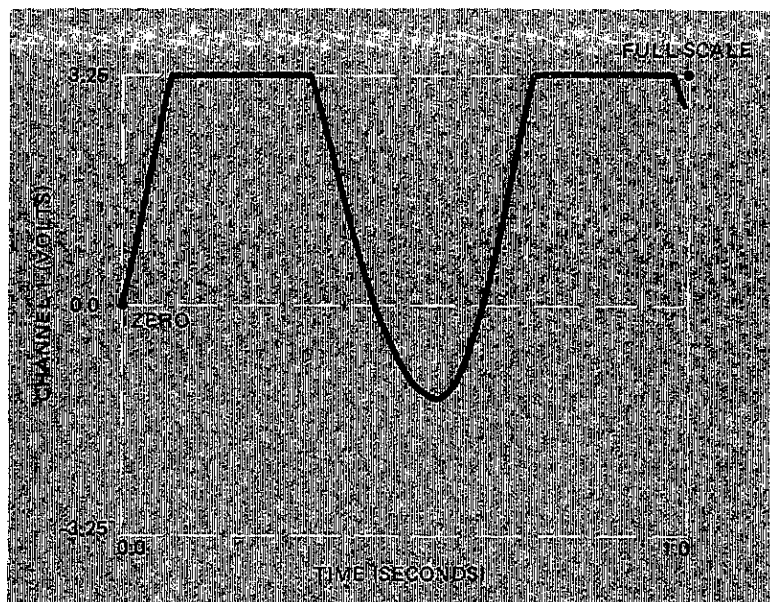

SETUP CONDITIONS	
TOTAL TIME	1.0 SECOND
RANGE 1	3.25 VOLTS

Default Value: 0.0 volts.

Range of Selectable Values: -100.0 to 100.0 volts.

The Offset Setup Condition

The **OFFSET** setup condition should be used in conjunction with **RANGE** when measuring signals having a median voltage V_{med} that is not equal to zero. **OFFSET** specifies a dc voltage offset that is applied in series with the input signal. This dc offset effectively shifts the median signal voltage onto the zero-voltage axis of the recording area, as shown by the illustration below.

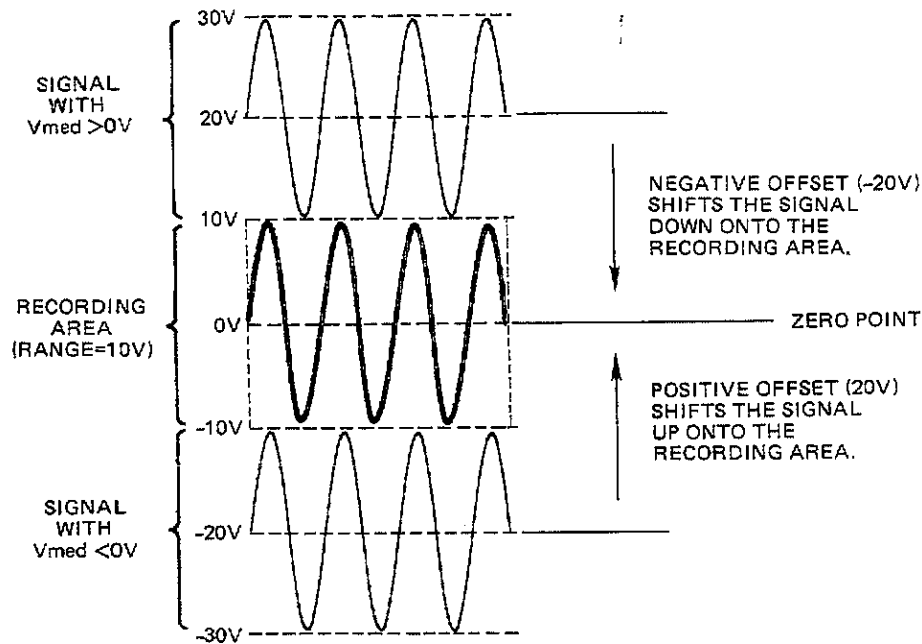

Shifting a Signal onto the Recording Area Using Offset

An offset value should be used that will allow the entire signal to be plotted within the recording area boundaries determined by the range equation. This value is given by the *offset equation* below.

$$\text{OFFSET} = -\frac{1}{2}(V_{max} + V_{min})$$

Because the mean signal voltage is shifted onto the zero-voltage axis (Y-axis) of the recording area when an offset condition is used, the voltage values assigned to the recording area Y-axis and boundaries are also shifted. The resulting Y-axis and boundary values are obtained by subtracting the offset value from the current values, so that

$$\text{Upper Boundary} = (\text{RANGE}) - (\text{OFFSET})$$

$$\text{Y-Axis} = - (\text{OFFSET})$$

$$\text{Lower Boundary} = (-\text{RANGE}) - (\text{OFFSET})$$

The illustration below shows a recording area scaled for signal A (Channel 1 input) after using the range and offset values obtained from the range and offset equations. Note that the plotted signal uses the entire Y-axis range.

The Effect of Offset on Scaling

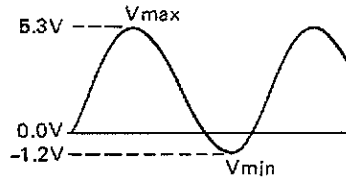

$$\begin{aligned} \text{SET} \\ \text{RANGE} &= \frac{1}{2} |V_{\max} - V_{\min}| \\ &= \frac{1}{2} |5.3 - (-1.2)| \text{ VOLTS} \\ &= 3.25 \text{ VOLTS} \end{aligned}$$

$$\begin{aligned} \text{SET} \\ \text{OFFSET} &= -\frac{1}{2} (V_{\max} + V_{\min}) \\ &= -\frac{1}{2} (5.3 - 1.2) \text{ VOLTS} \\ &= -2.05 \text{ VOLTS} \end{aligned}$$

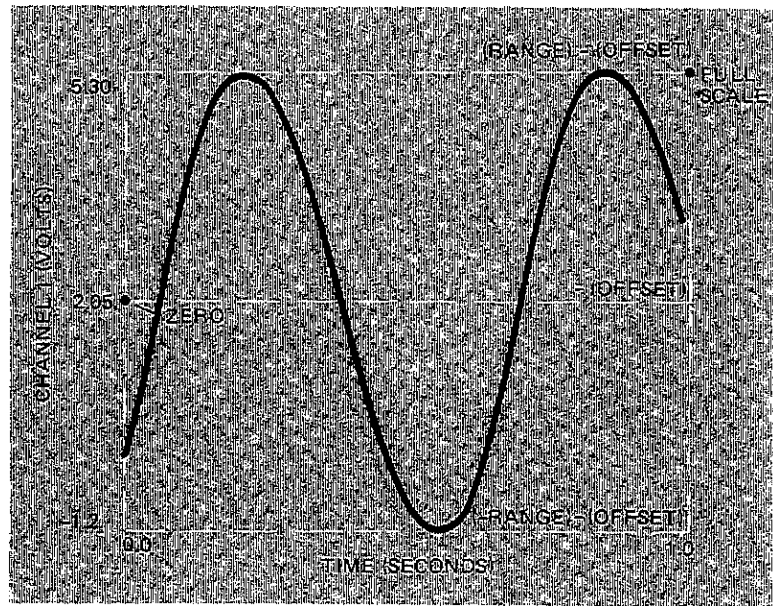

SETUP CONDITIONS	
TOTAL TIME	1.0 SECOND
RANGE 1	3.25 VOLTS
OFFSET 1	-2.05 VOLTS

You may want to round the values for V_{\max} (round up) and V_{\min} (round down) so that the resulting range and offset values are whole numbers. Rounding V_{\max} and V_{\min} results in a recording area with convenient boundary values and provides some headroom for the recorded signal. This is shown by the following illustration for a recording area prepared for plotting signal A using rounded values for V_{\max} and V_{\min} . Note that the preceding equations for determining the offset Y-axis and boundary values are still valid.

For versus-chan3 measurements, use the range and offset equations to determine the appropriate range and offset settings for Channel 3. The X-axis is scaled according to the Channel 3 settings in a manner identical to the versus-time examples given previously.

NOTE: When using an offset setting that exceeds \pm full-scale range, inaccuracy of the indicated offset value can be up to $\pm 3\%$ of full-scale range. ■

SIGNAL A
 $V_{max} = 5.3$ VOLTS
 ROUND V_{max} UP TO 6.0 VOLTS
 $V_{min} = -1.2$ VOLTS
 ROUND V_{min} DOWN TO -2.0 VOLTS

SET
 $RANGE = \frac{1}{2} |V_{max} - V_{min}|$
 $= \frac{1}{2} 6.0 - (-2.0)$
 $= 4.0$ VOLTS

SET
 $OFFSET = -\frac{1}{2} (V_{max} + V_{min})$
 $= -\frac{1}{2} (6.0 - 2.0)$
 $= -2.0$ VOLTS

Rounding V_{max} and V_{min} to Modify Scaling

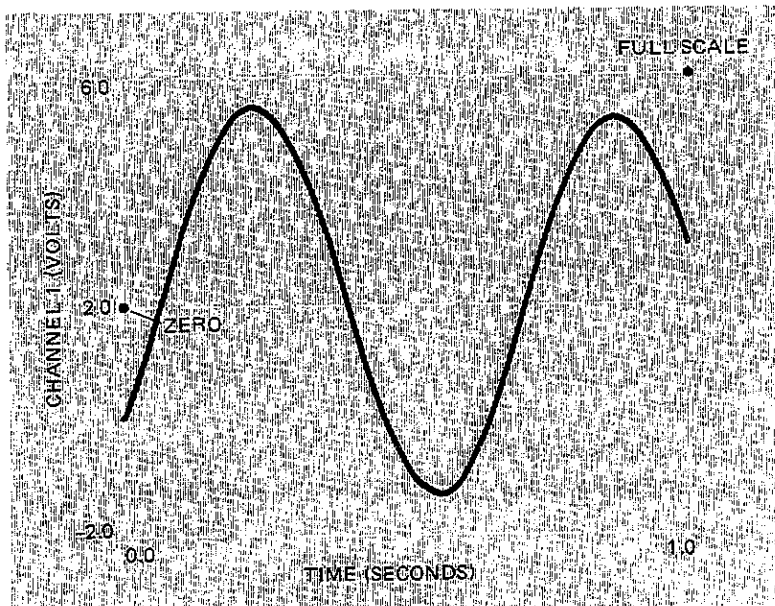

SETUP CONDITIONS	
TOTAL TIME	1.0 SECOND
RANGE 1	4.0 VOLTS
OFFSET 1	-2.0 VOLTS

Setup Operations

Offset Restrictions

A valid **OFFSET** setting for any given channel cannot exceed $\pm 200\%$ of the channel **RANGE** setting. Violating this restriction will cause the channel's **OFFSET** indicator to blink on and off, signaling an offset error condition. If a measurement is performed during such a condition, erroneous results will be obtained and the plot will be clipped. This restriction, along with the 100-volt limits of selectable offset values, results in the following limitations for valid offset values:

$$OFFSET \leq \begin{cases} 100 \text{ volts} \\ \text{and} \\ 2 \times RANGE \end{cases}$$

The maximum voltage that can be applied as channel input is 200 volts, dc or peak (using **RANGE** = 100 volts; **OFFSET** = ± 100 volts). In addition, if the **RANGE** and **OFFSET** equations are used for a signal having a median voltage V_{med} greater than the signal's peak-to-peak voltage, values for **RANGE** and **OFFSET** will be obtained that violate the second offset restriction listed above.

If either of the offset limitations is exceeded after using the range and offset equations, the following steps will provide settings that will yield the greatest accuracy:

1. Set **RANGE** equal to $1/3 |V_{max}|$ or $1/3 |V_{min}|$, whichever is greater.
2. Set **OFFSET** equal to twice the range setting computed in step 1. Use a negative offset if V_{med} is positive; use a positive offset if V_{med} is negative.

The following example illustrates this procedure. Shown is a signal having a median voltage V_{med} of 50 volts and a peak-to-peak range of 20 volts. Using the range and offset equations results in values that violate the second offset restriction. Applying the two steps given above resolves the problem and furnishes optimum range and offset values for the signal.

Modifying Range and Offset to Avoid an Offset Restriction

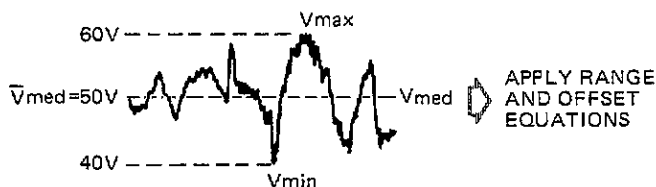

$$\begin{aligned} \text{RANGE} &= \frac{1}{2} |V_{max} - V_{min}| & \text{OFFSET} &= -\frac{1}{2} (V_{max} + V_{min}) \\ &= \frac{1}{2} |60 - 40| & &= -\frac{1}{2} (60 + 40) \\ &= 10 \text{ VOLTS} & &= -50 \text{ VOLTS} \end{aligned}$$

BUT...

$$|\text{OFFSET}| > 2 \times \text{RANGE}$$

(RESTRICTED CONDITION)

SO SET ...

1. **RANGE** = $\frac{1}{2} |V_{max}| = 20 \text{ VOLTS}$
2. **OFFSET** = $2 \times \text{RANGE} = -40 \text{ VOLTS}$
(NEGATIVE OFFSET USED BECAUSE $V_{med} > 0$)

Scaling and Drawing the Recording Area Grid (Preparing the Recording Area: Step 4)

The final procedure in preparing a recording area involves scaling and drawing the grid, which provides the customized graph paper onto which the measurement is plotted. The following steps, which are detailed in this section, are used to scale and draw a recording area grid:

1. The **GRID DIVISIONS** selections on the setup conditions menu are used to specify the number of X- and Y-axis grid divisions which will be created on each selected recording area quadrant.
2. The quadrants on which the specified grid is to be drawn are selected using the quadrant-select function (a multi-pushbutton operation).
3. The grid is drawn by pressing the **DRAW GRID** pushbutton.

These steps enable you to draw a recording area grid suited to the measurement application at hand. A grid may be drawn that correlates to the scaling and configuration of the recording area, and any available pen color may be used. The grid-drawing operations are discussed in detail in the following paragraphs.

Default Values: 25 (X-axis) and 18 (Y-axis) for A/A4-size paper.
38 (X-axis) and 25 (Y-axis) for B/A3-size paper.

The Grid Divisions Setup Conditions

Range of Selectable Values: 0 to 100, for the X- and Y-axes.

The selected grid-division values specify the configuration of the *quadrant grid* — the grid that is drawn on each selected quadrant. The following illustration shows a quadrant grid using a **GRID DIVISIONS X-AXIS** setting of 4, and a **GRID DIVISIONS Y-AXIS** setting of 3. The grid has been drawn only on Quadrant I of the illustrated recording area. Once established using the setup condition controls, however, the quadrant grid can be drawn on any or all quadrants using the quadrant-select function.

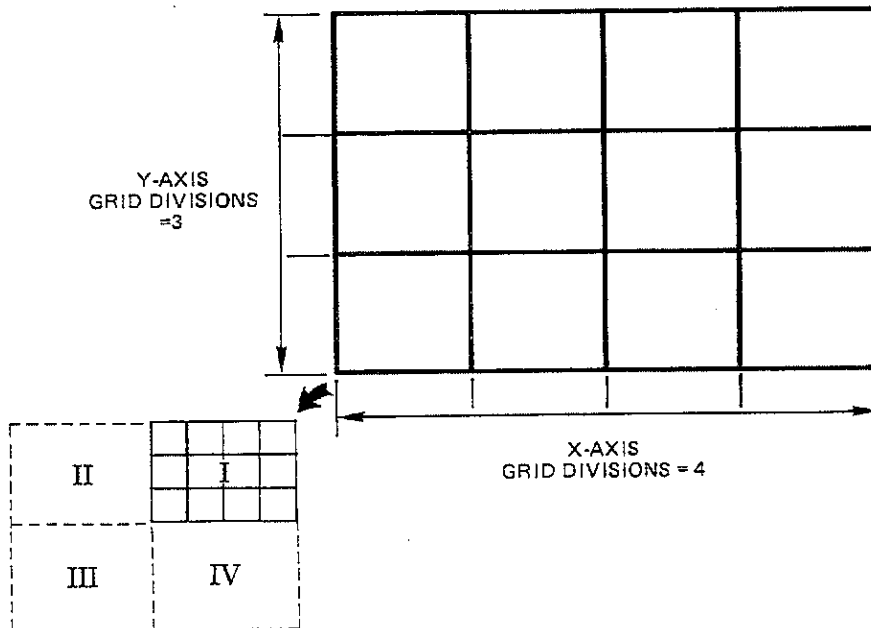

A Quadrant Grid

You will usually want to select **GRID DIVISION** values that correlate to your selected **TOTAL TIME** and/or **RANGE** values. This is demonstrated by the following example showing a recording area designed for a versus-time measurement. The specified quadrant grid (outlined with bold lines) has been drawn in Quadrants I and IV. Grid divisions have been selected to correlate with the **TOTAL TIME** and **RANGE 1** settings.

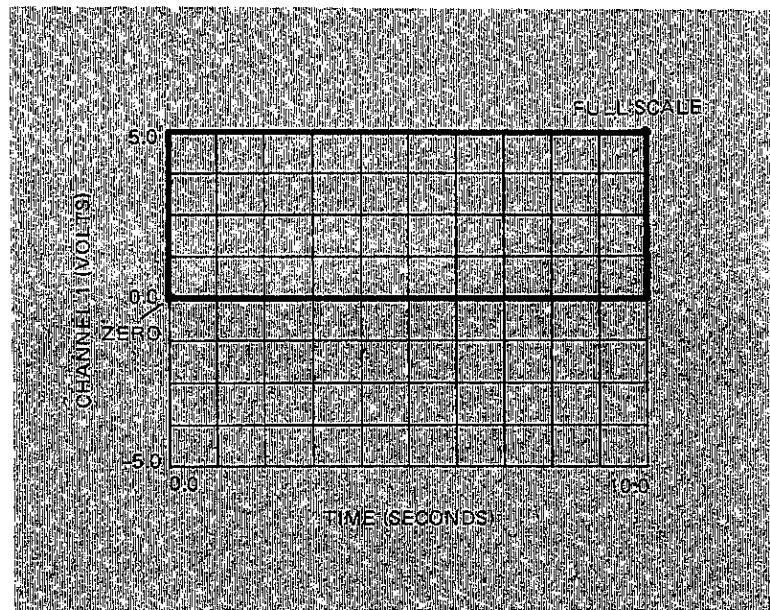

SETUP CONDITIONS	
TOTAL TIME	10 SECONDS
RANGE 1	5 VOLTS
OFFSET 1	0 VOLTS
GRID DIV. X-AXIS	10
GRID DIV. Y-AXIS	4

Selecting Quadrants and Drawing the Grid

The quadrant grid specified by the **GRID DIVISIONS** setup condition values may be drawn in any or all quadrants. Quadrants to receive the grid are selected using the quadrant-select function described below. Selections should be made that are appropriate for the application. For example, a versus-time plot only requires Quadrant I or Quadrants I and IV, whereas a versus-chan3 plot may require all quadrants.

A measurement may be plotted onto a recording area without drawing the grid, which might be desirable when only the overall appearance or shape of the signal needs to be seen. However, without a grid the relationship between the plotted signal and the X- and Y-axis scaling is difficult to visualize. For this reason, when plotted data is to be analyzed a grid should be provided. Grids may be drawn before or after data has been plotted.

To select quadrants and draw the grid, perform the following steps:

1. Use the **PEN SELECT** pushbuttons to select a pen for drawing the grid. To emphasize plotted data, use a light-colored pen for the grid. If your carousel is loaded as suggested in Chapter 2, select pen 4 (gold).
2. Access the **GRID DIVISIONS X-AXIS** menu selection using the menu selectors.
3. While holding down the **SHIFT** pushbutton, tap the **▼** menu selector once, as if accessing the **GRID DIVISIONS Y-AXIS** selection. Both **GRID DIVISION** indicators will remain on, indicating the quadrant-select function has been accessed. Refer to the following illustration.
4. The LCD displays the quadrant numbers that are currently selected to receive the grid. The default value is "1" (Quadrant I). Select the desired quadrants using the **PEN SELECT** pushbuttons numbered 1-4. **PEN 1** toggles the displayed "1" on and off, **PEN 2** toggles "2", and so on. Display only the quadrants you want to receive the quadrant grid. If no quadrants are selected, the HP 7090 will default to Quadrant I when the grid is drawn.

5. If "SHIFT" appears on the LCD, exit the shift function by pressing the **SHIFT** pushbutton. (This is necessary so that pressing **DRAW GRID** will not invoke a secondary function.)
6. Press **DRAW GRID**. The quadrant grid will be drawn on the selected quadrant(s) by the selected pen.

While the grid-select function is active . . .

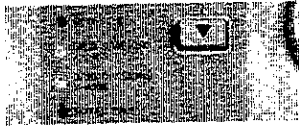

*Use the **PEN SELECT** pushbuttons to select quadrants.*

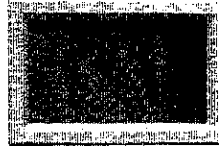
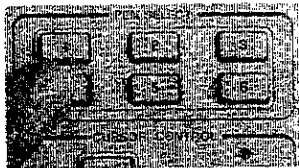

Selecting Quadrants to Receive the Grid

DISPLAYED
QUADRANT
SELECTIONS

NOTE: The quadrant-select function is automatically exited when the grid is drawn. However, the current quadrant selection is retained by the HP 7090 until a new selection is made, a **RESTORE SETUP** is performed, or until the instrument is initialized by pressing (**SHIFT**) **INIT** or turning the power off. The default quadrant-select value (Quadrant I) is established upon initialization. ■

Pens may not be selected while the quadrant-select function is active. If you need to select a pen after invoking the quadrant-select function, exit the function by pressing one of the setup conditions menu selectors. The selected quadrant values are retained by the HP 7090, and the **PEN SELECT** pushbuttons may be used to select a pen before pressing **DRAW GRID**.

A grid cannot be drawn outside the hard-clip limits; if any of the selected quadrants intersect the hard-clip limits, the grid will be drawn up to, but not beyond, the limits. When designing recording areas, therefore, always be certain to position **ZERO** and **FULL SCALE** so that required quadrants lie within the limits.

The zero point on the recording-area grid may be located easily by pressing the **ZERO** pushbutton. This moves the pen to the zero point and is especially helpful when a finely divided grid has been drawn on all quadrants. You can mark the located zero point for reference by pressing the **PEN DN** and **PEN UP** pushbuttons — the currently selected pen will mark the position. (To prevent accidental repositioning of the zero point, be sure to exit the zero-point positioning function by pressing **ZERO** a second time.)

Drawing the Standard Grid

Pressing (SHIFT) STANDARD GRID causes the HP 7090 to draw a standard centimetre grid (1 cm between grid lines) on the plotting medium with the currently selected pen. The standard grid is not affected by grid division settings or recording area size. For A- and A4-size paper the standard grid is always 25 × 18 cm; for B- and A3-size paper it is 38 × 25 cm. If desired, plots can be drawn on the standard grid by positioning the zero and full-scale points on intersecting grid lines so that the proper recording area is obtained.

Rotating the Recording Area

Recording areas are normally oriented so the X-axis is plotted along the long length of the paper. However, an HP 7090 function enables you to rotate recording areas 90° so the X-axis is plotted along the short length of the paper. This function may be desirable for applications that require rotated orientation of plotted measurements — preparing graphs for vertical display in a three-ring binder, for example. The illustration below shows recordings that were made using the rotate function on A/A4-size paper.

*Rotated Hardcopy Plots
(A/A4-Size Paper)*

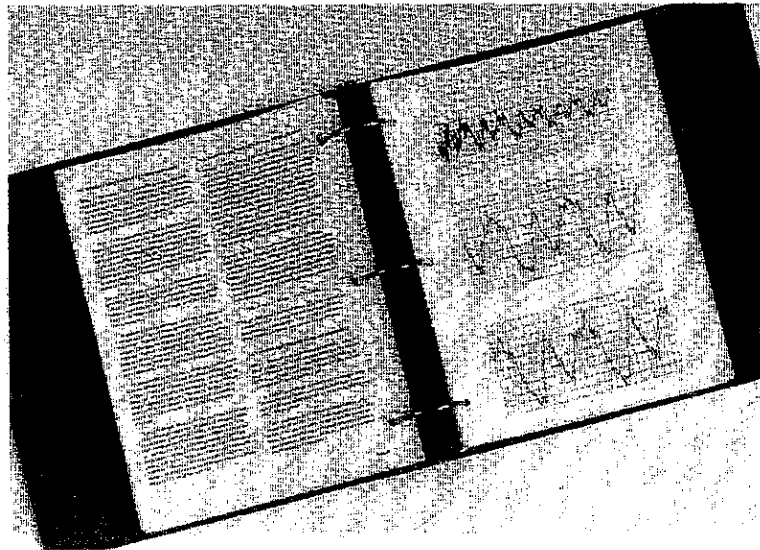

To invoke the rotate function, press SHIFT while holding down the FAST pushbutton on the left front panel. This positions the zero and full-scale points so that the X-axis runs along the short length of the paper. To verify this has occurred, press ZERO, then FULL SCALE. The pen holder will move to the initial rotated positions as shown by the following diagram.

The zero and full-scale points may be repositioned to obtain the desired recording area. (Remember that, when viewing the recording area with the positive X-axis extending to your right, the full-scale point should always be positioned above and to the right of the zero point.)

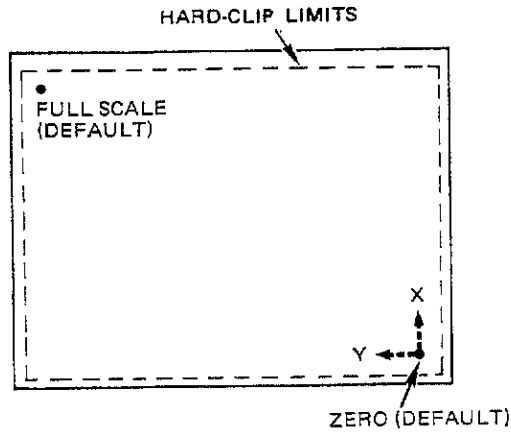
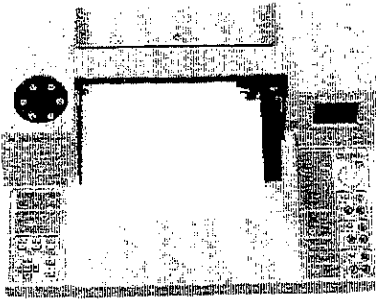

Rotated Locations of Default Zero and Full Scale (A/A4 Paper)

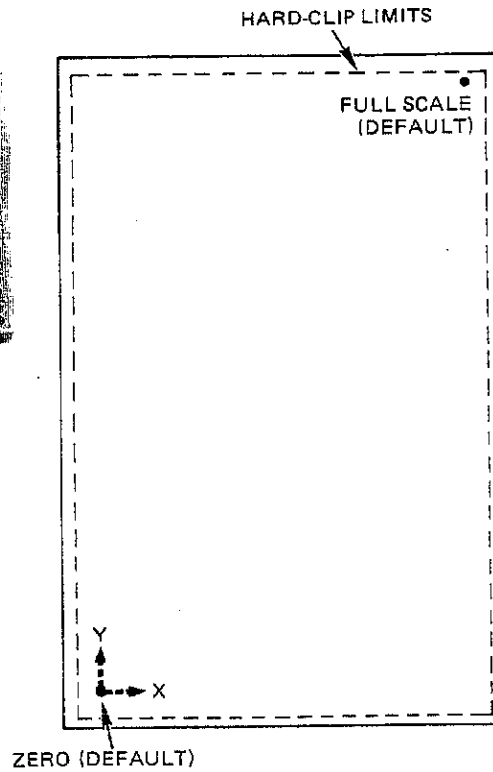
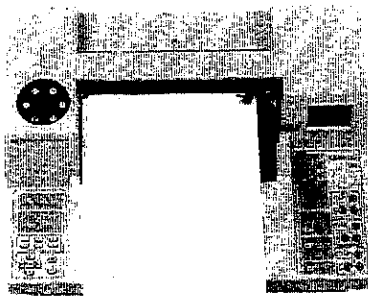

Rotated Locations of Default Zero and Full Scale (B/A3 Paper)

After invoking the rotate function, all subsequent recording areas, grids, and plots are oriented accordingly. The rotate function may be exited by 1) performing a front-panel initialization, 2) turning off the power, 3) restoring a non-rotated, saved setup, or 4) repeating the procedure used to invoke the rotate function (press **SHIFT** while holding down the **FAST** pushbutton). The

latter method should be used when you want the current buffer contents or setup conditions to be retained.

NOTE: After entering or exiting the rotate function, always verify rotation has occurred by checking the orientation of the default recording area (press **ZERO** and/or **FULL SCALE**.) ■

Connecting Analog Input Signals

⚠ WARNING

The HP 7090 is designed for laboratory use by qualified personnel. The operator must be aware of the hazards of any external voltages that are being measured.

Careful selection of external cables and probes is important based on the input signal voltage. Any voltage over 42 volts peak should be considered hazardous.

The HP 7090 accepts three analog signal inputs, one for each measurement channel. The input jacks are floating, guarded, and accept a dual banana plug. A switchable guard terminal is also available for each channel, allowing connection of an internal guard shield to an external common mode voltage source. Voltage overflow conditions are indicated by an overflow indicator. An input jack, guard terminal jack, guard switch, and overflow indicator are grouped for each channel as shown below.

Signal-Input Area

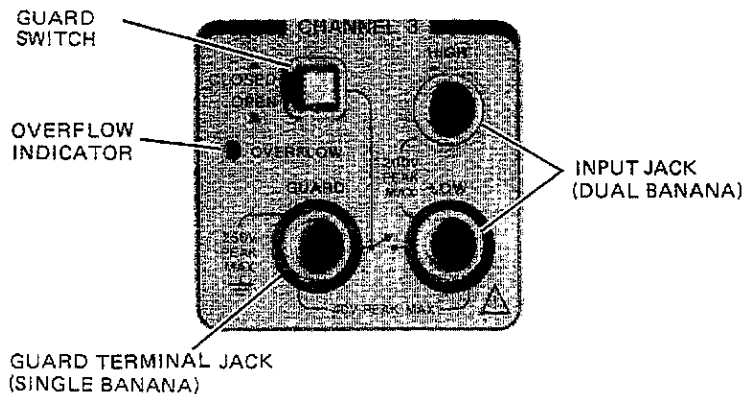

Using the Guard Switch

Each channel input jack is floating to reject common mode voltages (a potential source of error during sensitive measurements). When the guard switch is closed ("in" position) the channel's internal guard shield is connected to the low terminal, providing internal guarding and improving common mode rejection. The HP 7090 will reject common mode signals by more than 140 dB at dc and 100 dB at 60-Hz line frequency when the internal guard is used. The common mode rejection ratios are for 1-k Ω unbalance at the **LOW** terminal, using the most sensitive range.

For measurement applications in which an external guard connection is desired, the guard switch should be opened ("out" position). Opening the switch connects the guard shield to the guard terminal jack (refer to the following diagram). A single banana plug inserted into the guard jack may then be connected to the external common mode voltage source (common

mode voltages should not exceed 250 volts dc or peak ac when external guarding is used).

CAUTION

If no external guard connection is used, leave the guard switch in the closed ("in") position to internally connect the guard shield. Do not operate the HP 7090 without an internally or externally connected guard shield.

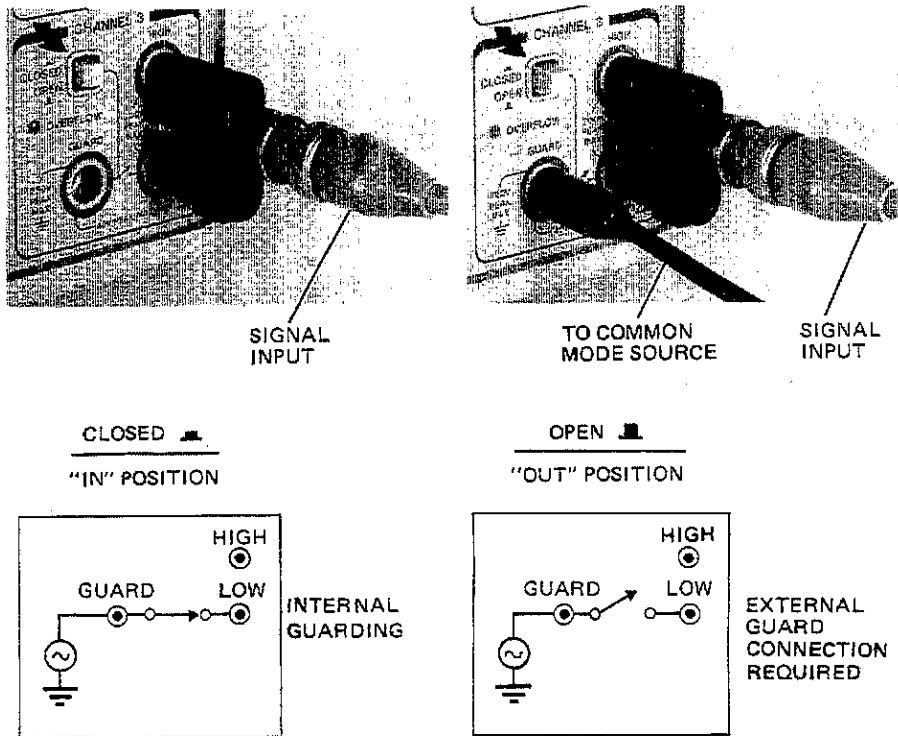

Guard-Switch Positions

Each input-signal jack accepts a dual banana plug. When applying input signals, be certain to insert the positive terminal of the plug into the HIGH port of the jack. The HP 7090 will accept peak or dc input voltages of up to 200 volts. A schematic of the input terminal circuitry is provided in Appendix B if you wish to determine impedance loading values.

Channel Input Signals

WARNING

Insert the mains power cord before connecting channel input signals.

CAUTION

Applying input voltages in excess of 200 volts dc or peak could damage the HP 7090.

For cases of extreme noise contamination of the ac power source, the ground lug located on the right side panel of the HP 7090 may be connected to the signal source chassis ground. In addition, sensitive measurements may be adversely affected in the presence of strong magnetic fields. If this occurs, reposition the HP 7090 to minimize field effect.

Overflow Conditions

The **RANGE** and **OFFSET** setup condition values for a given channel determine the full range of acceptable input voltages for that channel. The acceptable range is directly related to the boundaries of the recording area, where

$$\begin{aligned}\text{Upper Boundary} &= (\text{RANGE}) - (\text{OFFSET}) \\ \text{Lower Boundary} &= (-\text{RANGE}) - (\text{OFFSET})\end{aligned}$$

If any channel's input voltage exceeds the limits given by the channel's upper and lower boundaries (as determined by the equations above), the channel overflow indicator will turn on. Overflow conditions should be corrected by making the proper adjustments to the range and/or offset settings for the indicated channel. Data recorded during an overflow condition will be invalid, and the resulting plot will be clipped.

Displaying Input Voltages

Input signal voltages may be digitized and displayed on the LCD by accessing the data display mode. This mode includes two different data display functions, labeled **INPUT** and **PEN POSITION** on the right front panel. The input data-display function is used to display input voltages, allowing the HP 7090 to serve as a digital voltmeter. This function is often helpful in determining the voltage range of input signals.

To obtain a voltage reading and observe digitized input on the display, access the input data-display function by pressing the **DATA DISPLAY** selector to light the **INPUT** indicator. Select the channel to be displayed by pressing the appropriate Y-axis channel-select pushbutton (**CHAN 1**, **CHAN 2**, or **CHAN 3**). Channel 1 is selected automatically if no other selection is made. The lower, X-axis channel-select pushbuttons and indicators are disabled while the input data-display function is in effect.

The Input Data-Display Function

CHANNEL
SELECTED FOR
DISPLAY

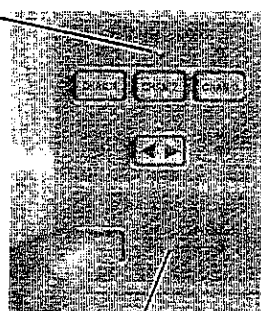

INPUT DATA DISPLAY
FUNCTION ACCESSED



DISPLAYED
INPUT VOLTAGE

In the data display mode, the LCD uses three digits to display input voltages. The selected input signal is sampled and displayed at about 2.5 times per second. Accuracy of the displayed values is dependent upon the range setting of the channel selected for display. (Refer to Appendix B for a complete listing of accuracy as a function of range settings.)

To exit the data display mode, press the data display selector to extinguish the **INPUT** indicator. If the **PEN POSITION** indicator turns on (which will occur unless the buffers are empty), press the data display selector again so that neither data display indicator is lit. Exiting the data display mode returns the LCD to its default function — displaying setup condition values.

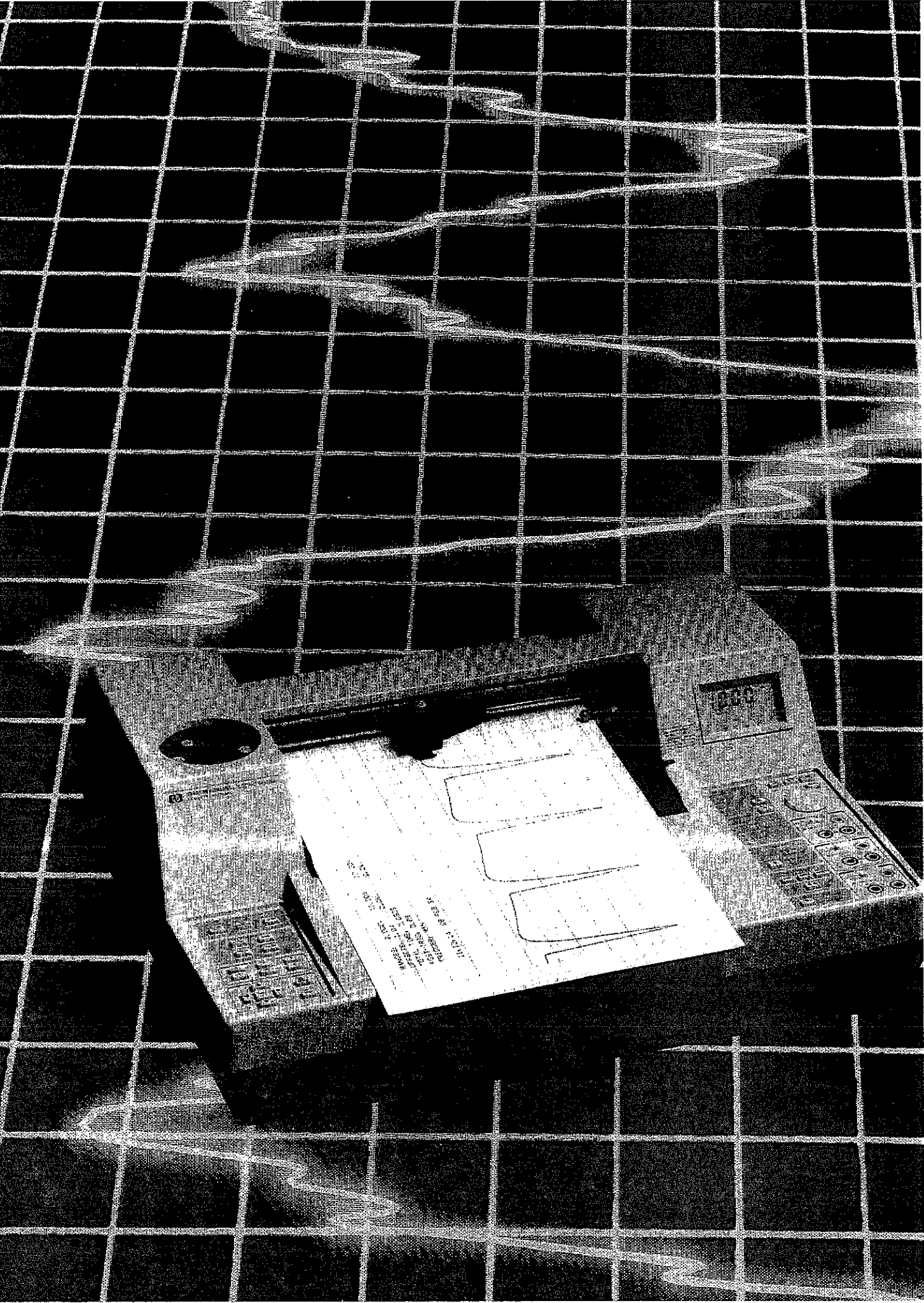

6310

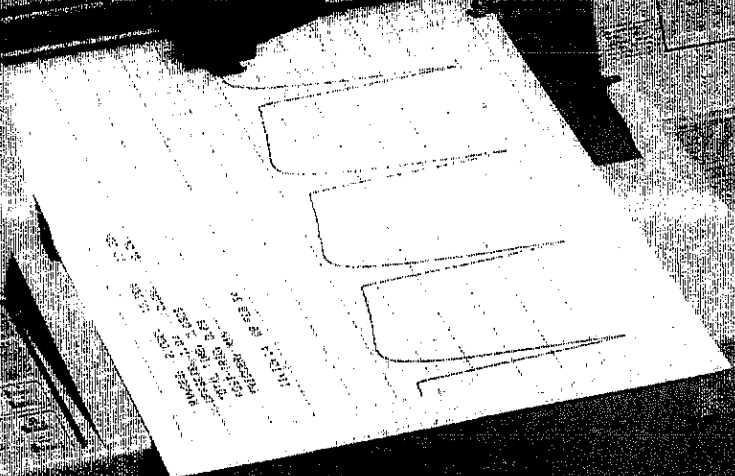

11. 23. 84 11. 21. 74
11. 23. 84 11. 21. 74
11. 23. 84 11. 21. 74
11. 23. 84 11. 21. 74
11. 23. 84 11. 21. 74
11. 23. 84 11. 21. 74
11. 23. 84 11. 21. 74
11. 23. 84 11. 21. 74
11. 23. 84 11. 21. 74
11. 23. 84 11. 21. 74

Control panel area featuring several knobs and buttons. Labels include:

- POWER
- LEVEL
- PHASE
- REVERB
- REPEAT
- STOP
- START
- STOP
- START

Chapter 4

Performing Direct and Buffered Recordings

This chapter contains information on the direct and buffered recording modes. The direct recording mode is used to produce real-time recordings directly onto the plotting medium. The buffered recording mode uses internal buffers to store digitized input data, which can be recalled by the HP 7090 to produce single or multiple plots.

Step-by-step instructions for performing direct and buffered recordings and plots are included in this chapter, as well as a description of the pen position data-display mode, which you can use to label individual data points plotted from the buffers. In addition, information is provided on connecting an oscilloscope to the HP 7090 to preview buffer contents prior to plotting.

The Direct Recording Mode

When used in the direct recording mode, the HP 7090 functions as an X-Y or Y-T analog recorder and may be used to produce real-time plots of low-frequency input signals. Individual plots are drawn onto the currently specified recording area. The sampling rate used for all direct recordings is 250 samples per second.

Nominal slewing speed in the direct recording mode is 125 cm/s; acceleration is approximately 196 m/s^2 (2 g's). Sweep time for Y-T (versus-time) recordings is determined by the **TOTAL TIME** setting, and times of 1 second to 24 hours may be used.

The start of direct recordings may be triggered *manually* (recording is activated by pressing a front-panel pushbutton), *externally* (recording is activated by an externally-applied signal), or *internally* (recording is activated when selected trigger conditions are met). Post-trigger times may also be specified. (A complete description of trigger modes and post-trigger time is contained in Chapter 5.)

Performing a Direct Recording (Versus Time)

To perform a versus-time direct recording, follow these steps:

1. Using the **CHANNEL SELECT** controls, select a single channel (1, 2, or 3) as the Y-axis variable. Select **TIME** for the X-axis.

More than one Y-axis channel can be plotted on a single recording area. However, the channels to be plotted must be selected and recorded individually.

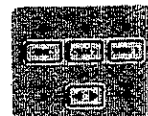

Select the X and Y-Axis Variables

Prepare the
Recording Area



2. Prepare an appropriate recording area as follows. (Refer to Chapter 3 for details.)
 - a. Position **ZERO** and **FULL SCALE**.
 - b. Set **RANGE** and **OFFSET** for the selected Y-axis channel.
 - c. Set **TOTAL TIME** to scale the X-axis.
 - d. Grid the recording area.

For direct, versus-time recordings, **TOTAL TIME** determines the pen sweep time. Times settings of 1 second to 24 hours may be used. If a total time of less than 1 second is selected, the HP 7090 will reset **TOTAL TIME** to 1 second and perform a 1-second recording when the direct recording is initiated.

Select a Pen



3. Select a pen color appropriate for plotting the selected channel using the **PEN SELECT** pushbuttons.

Select the
Trigger Mode

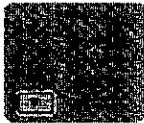

4. Use the **TRIGGER** mode selector to select the desired trigger mode.

For manual, front-panel triggering, select the **MANUAL** mode. (The manual trigger mode is automatically selected during initialization.)

The external or internal trigger modes may also be selected for direct recordings, as well as post-trigger time delays. These trigger modes and operations are described in Chapter 5.

Initiate the
Trigger Search



5. Press **RECORD DIRECT** to initiate the trigger search.

The pen will move to the recording area's zero point. The pen remains in the up position until the selected trigger is received, at which time the pen lowers to draw the trace.

There is no trigger search for the manual trigger mode — pressing **RECORD DIRECT** triggers the recording immediately (unless a post-trigger time delay is specified).

For the external and internal trigger modes, the pen is lowered and plotting begins when the selected trigger is received (unless a post-trigger time delay is specified).

Status of the trigger search is shown by the **TRIGGER SEARCH** indicator, which is continuously lit during a trigger search and blinks during a post-trigger time delay.

The pen is automatically lifted when the recording is completed. Direct recordings can be stopped in progress by pressing **STOP** — this will lift the pen and terminate the recording.

Recording
Completed



Performing a Direct Recording (Versus-Chan3)

Channel 1 or 2 may be plotted against Channel 3 in the direct recording mode. The procedure is similar to that for direct versus-time recordings. However, for versus-chan3 direct recordings that are manually triggered, the **TOTAL TIME** setting has no effect on the duration of the recording. This feature allows a continuous, free-running measurement, for which lowering and lifting of the pen and termination of the measurement are performed manually.

To perform a versus-chan3 direct recording:

1. Select Channel 1 or 2 as the Y-axis variable. Select **CHANNEL 3** as the X-axis variable.



Select the X and Y-Axis Variables

2. Prepare an appropriate recording area as follows. (Refer to Chapter 3 for details.)



Prepare the Recording Area

- a. Position **ZERO** and **FULL SCALE**.
- b. Set **RANGE** and **OFFSET** for the selected X- and Y-axis channels.
- c. Set **TOTAL TIME** for time-limiting of the recording (external or internal trigger mode only).
- d. Grid the recording area.

TOTAL TIME settings are ignored for manually-triggered measurements. For external or internal triggering, **TOTAL TIME** settings of 1 second to 24 hours may be used to select the recording duration. If a total time of less than 1 second is selected, the HP 7090 will reset **TOTAL TIME** to 1 second and perform a 1-second recording when the trigger is received.

3. Select an appropriate pen color using the **PEN SELECT** pushbuttons.

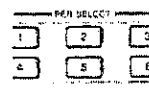

Select a Pen

4. Use the **TRIGGER** mode selector to select the desired trigger mode.

For manual, front-panel triggering, select the **MANUAL** mode. The external or internal trigger modes may also be selected for direct recordings, as well as post-trigger time delays. These trigger modes and operations are described in Chapter 5.



Select the Trigger Mode

5. Press **RECORD DIRECT** to initiate the trigger search.

The pen holder and paper will move so that the pen is above the recording area's zero point. The HP 7090 will then respond to the X,Y input with the pen raised until the trigger is received, at which time the pen will lower and draw the plot.



Initiate the Trigger Search/Recording

To start recording for the manual trigger mode, press **PEN DN** to latch the pen in the "down" position. (Pressing **PEN UP** will latch the pen in the "up" position.) The pen may also be controlled remotely using the external-pen connection described on the following page.

Terminate the
Recording

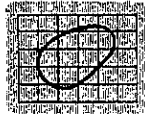

For the external and internal trigger modes, the pen is lowered and plotting begins when the appropriate trigger is received.

- To stop the recording for the manual trigger mode, press the **STOP** push-button. This raises the pen (if it is lowered) and stops the measurement.

For the external or internal trigger mode, the recording is stopped automatically when the **TOTAL TIME** has elapsed, or you can stop it at any time by pressing **STOP**.

The External-Pen Connector

A BNC connector, labeled **EXT PEN** (external pen), is provided on the right side panel of the HP 7090 to permit remote-controlled penlift. The connector is active only during manually-triggered, versus-chan3 direct recordings, and you can use it (instead of the **PEN UP** and **PEN DN** pushbuttons) to remotely raise or lower the pen.

The positive terminal of the connector is pulled high (5-volt TTL level) when a versus-chan3 direct recording is manually triggered — this holds the pen in a raised position. A falling TTL level or contact closure to ground applied to the positive **EXT PEN** terminal will lower the pen. Similarly, a rising TTL level or opening the ground contact will raise the pen.

The Buffered Recording Mode

Each of the three input channels of the HP 7090 has its own A/D converter and buffer. A channel buffer consists of a stack in RAM memory of 1000 memory locations — each location is used to store a digitized voltage value. During a buffered recording, the channel input voltages are simultaneously sampled, digitized, and stored in their buffer at a uniform rate determined by the **TOTAL TIME** setting. Each channel buffer is completely filled within that time.

A Channel Buffer

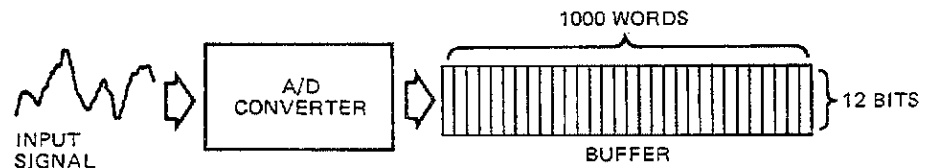

Following completion of a buffered recording, the digitized data stored in the buffers can be recalled and plotted on paper. The HP 7090 performs as a vector plotter — the data points mapped onto the recording area are connected by vectors during plotting to reproduce the recorded waveforms.

Measurement graphics are created from the recorded buffers as shown by the following plot of a Channel 1 input signal versus time. To draw the plot, the 1000 voltage values stored in the Channel 1 buffer stack were pulled from the buffer and mapped onto the recording area. The arrow in the figure points to a single Y-axis voltage value that has been plotted against the appropriate time element (each equal to **TOTAL TIME/1000**) on the X-axis.

*Plotting Buffered Data
(Channel 1 vs Time)*

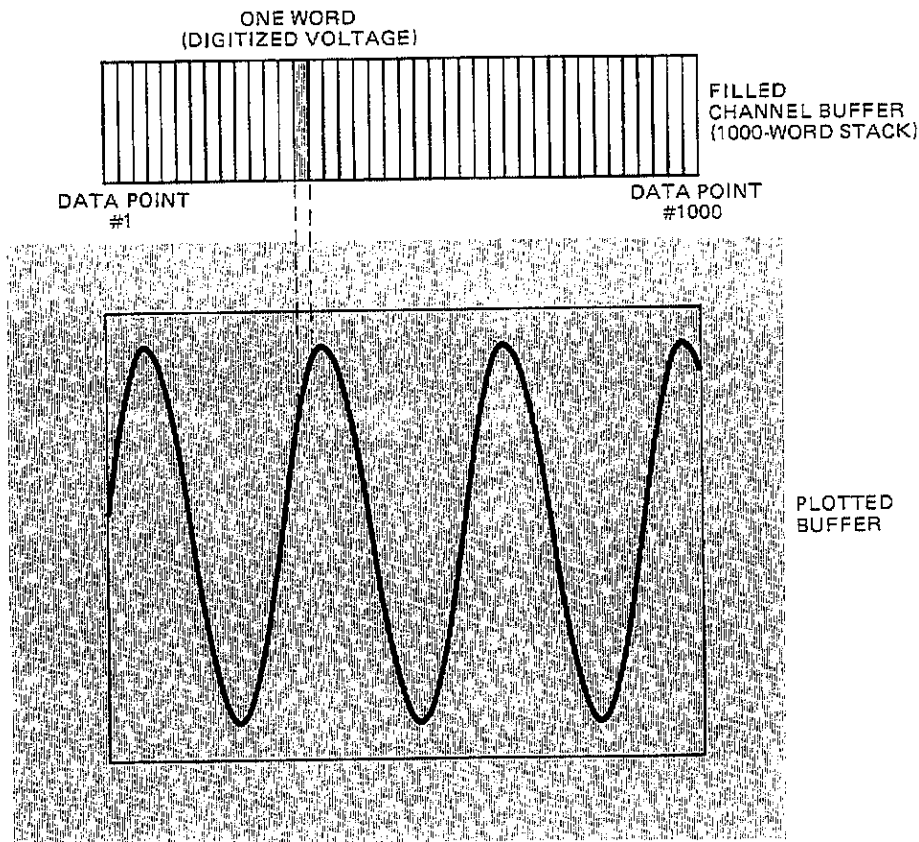

For a versus-chan3 plot, the contents of the Channel 3 buffer are used for the X-coordinate values; the contents of the selected Y-axis channel are used for the Y-coordinate values. The resulting 1000 coordinate pairs are plotted sequentially on the prepared recording area.

Data stored in the buffers during an individual recording is retained until another buffered recording is made, the power is turned off, or the HP 7090 is initialized. Data retained in the buffers may be recalled again and again to create multiple plots. In addition, the dimensions of recording areas used for plotting can be altered for different plots by repositioning the zero and full-scale points — plotted data is rescaled accordingly.

Buffered recordings can be triggered manually, externally, or internally. In addition to post-trigger time selections, pre-trigger times can be specified, enabling you to record pre-trigger data in the buffers.

Recording

Minimum Sample Rate

To accurately record a waveform so that it may be reconstructed from stored data, the input signal must be sampled often enough for its characteristics to be apparent from the sampled data. This is illustrated below for a signal of frequency f (black line). The colored line shows the signal as it would be reconstructed from data recorded at various sample rates. Clearly, higher sampling rates improve reconstruction.

The Effect of Sample Rate upon Signal Reconstruction

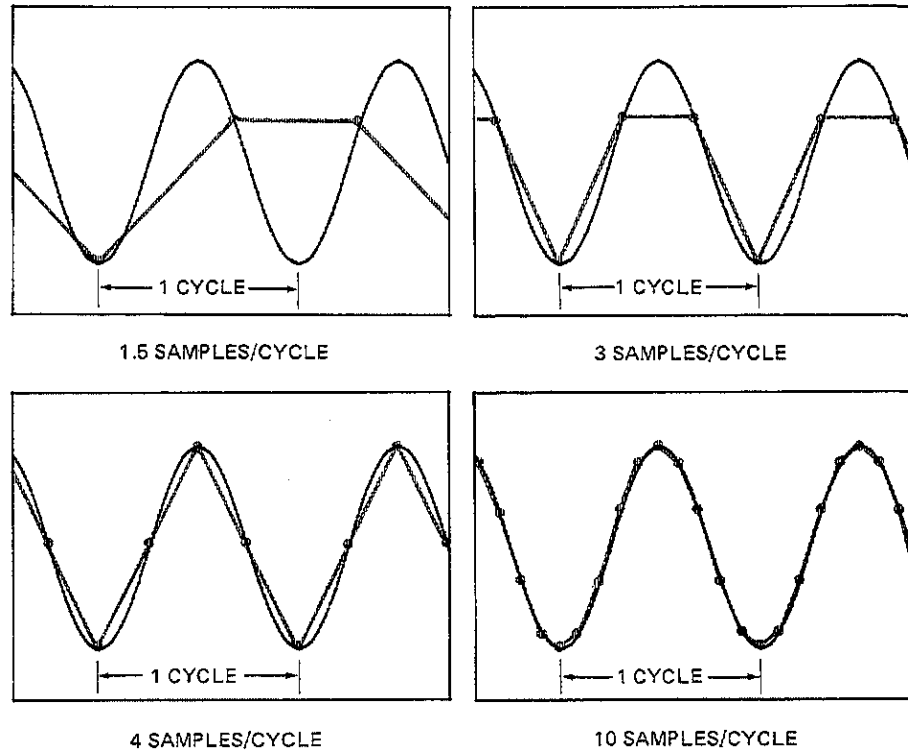

During a buffered recording, each buffer obtains 1000 input-signal samples with the **TOTAL TIME**. The resulting sample rate R may therefore be expressed as

$$R = 1000 / \text{TOTAL TIME}$$

To assure data plotted from the buffers will accurately portray the recorded signals, a minimum of 10 samples per cycle of the maximum input frequency f_{max} should be obtained. Because the sample rate R is determined by the **TOTAL TIME** setting according to the equation above, accurate reconstruction may be obtained by setting

$$\text{TOTAL TIME} \leq 100 / f_{\text{max}}$$

Performing a Buffered Recording (Versus Time or Versus Chan3)

The following steps may be used to perform a versus-time or versus-chan3 buffered recording:

1. Establish the recording area scaling as follows. (Refer to Chapter 3 for details.)

- a. Set **RANGE** and **OFFSET** for all channels to be recorded and plotted. The Channel 1 and/or 2 (and/or Channel 3 in a versus time measurement) **RANGE** and **OFFSET** settings scale the recording area's Y-axis.

For versus-chan3 recordings, the Channel 3 **RANGE** and **OFFSET** settings scale the recording area X-axis.

- b. Set **TOTAL TIME** to establish the recording duration (buffer-fill time) and sample rate.

For versus-time recordings, the **TOTAL TIME** setting scales the recording area's X-axis.

2. Use the **TRIGGER** mode selector to select the desired trigger mode.

For manual, front-panel triggering, select the **MANUAL** mode. (The manual trigger mode is automatically selected during initialization.)

The external or internal trigger modes may also be selected, as well as post- or pre-trigger times. (Trigger modes and operations are detailed in Chapter 5.)

3. Press **FILL BUFFER** to initiate the trigger search.

For the manual trigger mode, there is no trigger search, and the buffers begin filling when **FILL BUFFER** is pressed (unless a post-trigger time delay has been specified).

For the external trigger mode, the buffers begin filling when the external-trigger signal is received. For the internal trigger mode, the buffers begin filling when the Channel 1 input meets the selected trigger conditions.

Status of the trigger search is shown by the **TRIGGER SEARCH** indicator. The indicator is continuously lit during a trigger search, and blinks during a post-trigger time delay.

Status of the buffer-fill process is shown by the **BUFFER FILLED** indicator. The indicator blinks while the buffers are filling, and remains lit when the buffers are filled.

4. Use the upper three **CHANNEL SELECT** pushbuttons to select the Y-axis variable(s).

Use the lower **CHANNEL SELECT** pushbutton to select the X-axis variable. Select **CHANNEL 3** for versus-chan3 plots; select **TIME** for versus-time plots.

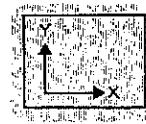

Scale the Recording Area



Select the Trigger Mode



Initiate the Trigger Search/Recording

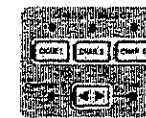

Select the X- and Y-Axis Variables

Position and Grid
the Recording
Area



Plot the Buffer(s)

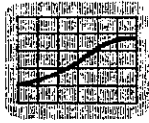

5. Position and grid a recording area to receive the selected data as follows. (Refer to Chapter 3 for details.)
 - a. Position **ZERO** and **FULL SCALE** to establish the size and location of the recording area.
 - b. Grid the recording area.
6. Press **PLOT BUFFER** to plot the selected variables (buffer contents) on the prepared recording area.

For buffered recordings, the HP 7090 automatically makes pen selections that correlate to your Y-axis channel selection(s) — pen 1 is used for **CHAN 1**, pen 2 for **CHAN 2**, and pen 3 for **CHAN 3**.

If more than one Y-axis channel has been selected for plotting, the channels are plotted in numerical order, beginning with the lowest-numbered channel.

The pen is lifted when the contents of all selected buffers have been plotted. If you want to stop a buffer plot before it is finished, press **STOP** (doing so will not erase the current buffer contents).

7. Repeat steps 4–6 to create duplicate or alternative plots of the buffer contents. Versus-time or versus-chan3 plots can be drawn from a single buffer-fill process.

Displaying and Labeling Buffered Data Points

The HP 7090 data display mode includes two different functions, labeled **INPUT** and **PEN POSITION** on the front panel. The pen position function is normally used to locate and label points of interest on buffer plots. Accessing the pen position function allows you to display the contents of a selected buffer on the LCD after a buffered recording has been performed. The HP 7090 can also mark and label the coordinates of selected data points.

To display and label buffered data points, perform the following steps:

1. Select the channel whose buffer contents are to be displayed by using the Y-axis **CHANNEL SELECT** pushbuttons. Only one channel may be selected at a time. Select the appropriate X-axis variable (**TIME** for versus-time plots, **CHANNEL 3** for versus-chan3 plots).
2. Access the pen position function by using the **DATA DISPLAY** selector to light the **PEN POSITION** indicator (the pen position function is not accessible if the buffers are empty).

When the pen position function has been selected, the pen and paper will move so that the pen is positioned over the recording area coordinates of the first buffered data point specified by the X- and Y-axis selections made in step 1. At the same time, the LCD will display the Y-axis coordinate (voltage) of the first buffered data point.

3. Use the pen **CURSOR CONTROLS** to access the buffered data. Hold down the **►** or **▲** cursor control to move through the buffer from the beginning (data point #1) to the end (data point #1000). Similarly, hold down the **◀** or **▼** cursor control to move through the buffer in the opposite direction.

As the buffer contents are accessed, the pen is moved over the corresponding data points on the recording area, and the Y-axis coordinates are displayed on the LCD. Three significant figures are used to display the values.

Hold down the **FAST** pushbutton in conjunction with a cursor control to move through the buffer quickly. Tap the appropriate cursor control repeatedly to step through the buffer and examine individual data point values on the display.

If the buffer(s) have been plotted, the correlation between the plot, cursor position, and displayed voltage are immediately apparent. The voltage values of individual points of interest along the plot can easily be determined.

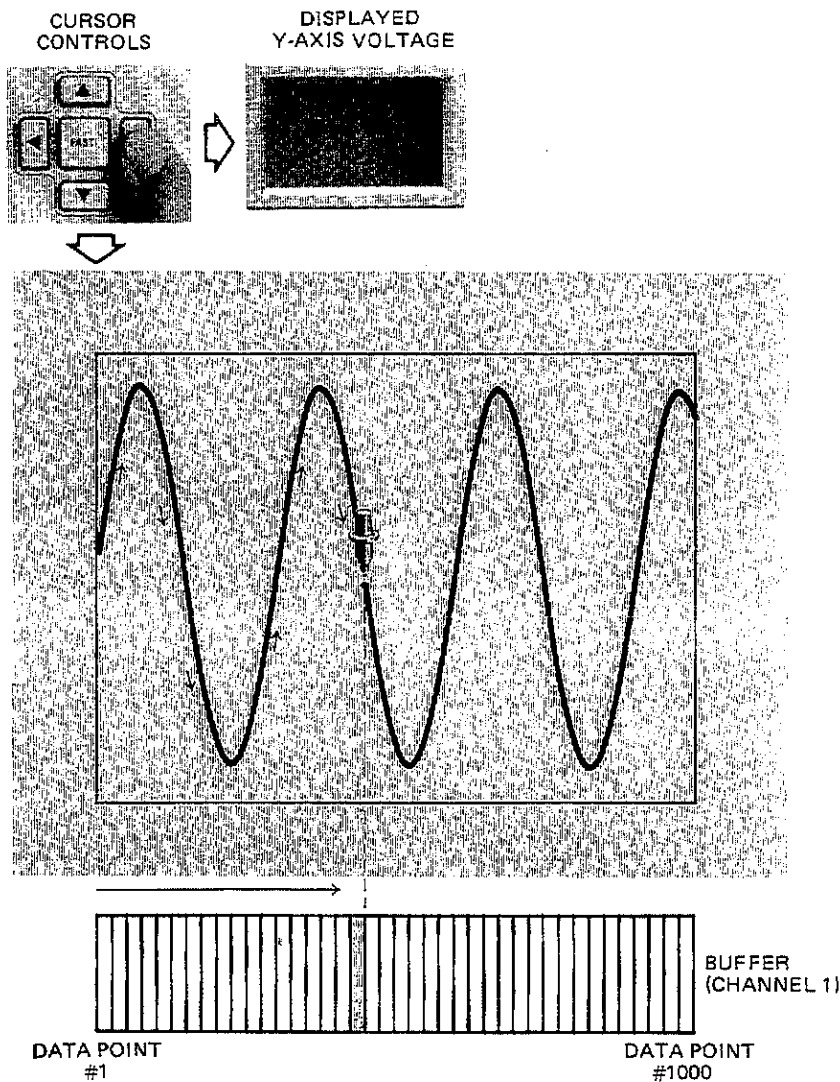

Tracking and Displaying Buffer Contents

4. While the pen position function is active, the X- and Y-coordinate values of any selected point on a plot can be labeled by selecting an appropriate pen and pressing **(SHIFT) DATA DISPLAY**. The currently selected pen will place a **+** on the point and label it as shown by the following illustration. Labels cannot be drawn outside the hard-clip limits. (If you like, you can change the size of the characters used to label data — refer to Chapter 6.)

If more than one (Y-axis) channel has been plotted, you can display and label the Y-axis values for any common X-axis coordinate by switching between the Y-axis CHANNEL SELECT selections.

Pen Position Labels

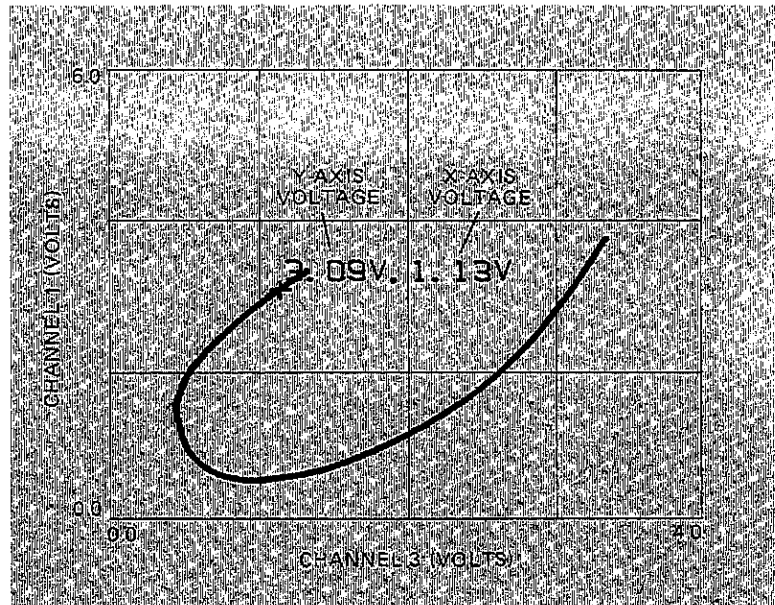

VERSUS - CHAN 3 PLOT

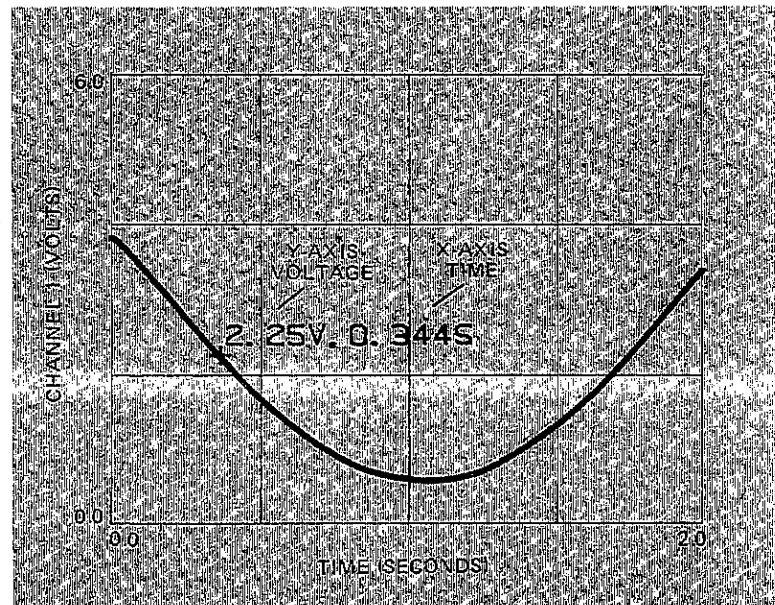

VERSUS - TIME PLOT

Displaying Buffer Contents on an Oscilloscope

Two **SCOPE OUT** connectors (located on the right side panel) are provided for connecting the HP 7090 to an oscilloscope, enabling you to view buffer contents on the scope. This feature is used to preview stored waveforms before plotting them on paper, or for observing the progression of recorded data points while the buffers are filling.

To connect an oscilloscope to the HP 7090, refer to the diagram below. Connect the **VERT** BNC connector to the Channel A (vertical) input of the oscilloscope. Connect the **HORIZ** BNC connector to the Channel B (horizontal) input of the scope.

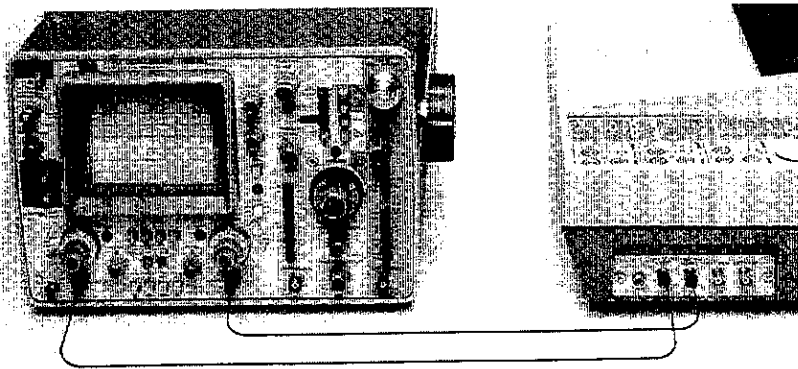

Oscilloscope
Connections

Use the **CHANNEL SELECT** pushbuttons to select the buffered Y-axis and X-axis output.* Versus-time or versus-chan3 relationships may be selected for viewing. The Y-axis selection(s) is fed to the Channel A (vertical) scope input; the X-axis selection is fed to the Channel B (horizontal) scope input.

The output voltage range at each of the **VERT** and **HORIZ** output connectors is -10 to +10 volts. The A and B scale (volts/division) settings of the scope should be set to allow complete display of both inputs, and the beam centered for "zero" input. Set the input coupling for both scope channels to "dc." Set the scope's display switch to permit viewing of Channel A versus Channel B.

When the buffers are filled (or while they are filling), data for the selected X- and Y-axis channels are shown on the oscilloscope display. Y-axis buffer selections may be selected for viewing individually or simultaneously, and "time" or Channel 3 may be selected for X-axis display. (Time output appears as a positively-sloped ramp when viewed alone on the scope.)

*Because the "scope out" range is proportional to the HP 7090 **RANGE** setting, input signal voltages portrayed on the oscilloscope display can be estimated using the formula

$$\text{Voltage} = (N_{\text{div}}) \times (\text{volts/division}) \times (\text{RANGE} - \text{OFFSET}),$$

where N_{div} is the graticule-division value of the displayed signal voltage and volts/division is the oscilloscope scale setting. **RANGE** and **OFFSET** are the HP 7090 setup condition values relevant to the displayed channel.

Output from the buffers is available for viewing on the scope only when the HP 7090 is idle. If you invoke any function on the HP 7090, the scope display will temporarily vanish until the selected function has been completed.

*Viewing Buffer Contents
on an Oscilloscope.
The Channel 1 and 2 buffers
have been selected for viewing
on Channel A of the scope,
versus time on Channel B.
A hardcopy plot has also
been drawn, using the same
buffered data.*

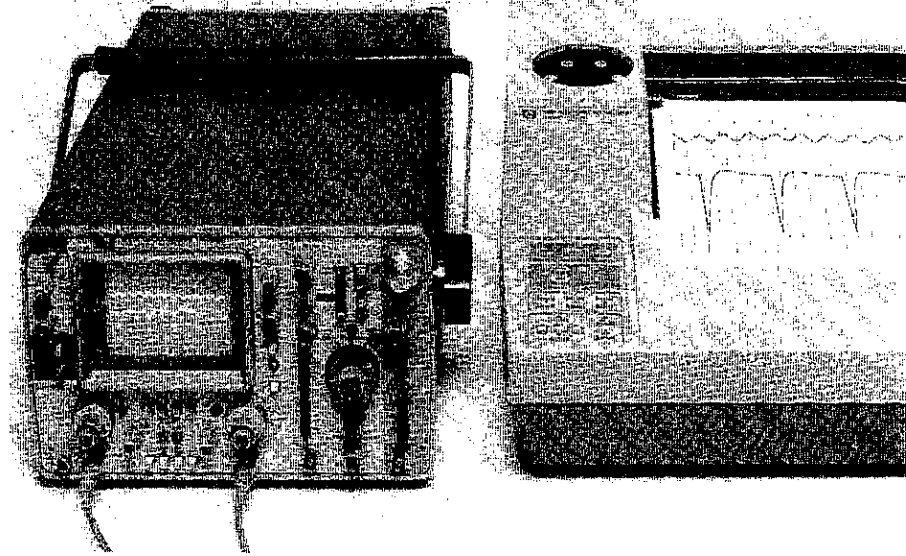

TRIGGER

INT
(CHAN II)

ABOVE LEVE

EXTERNAL

BELOW LEV

MANUAL

INSIDE
WINDOW

OUTSIDE
WINDOW

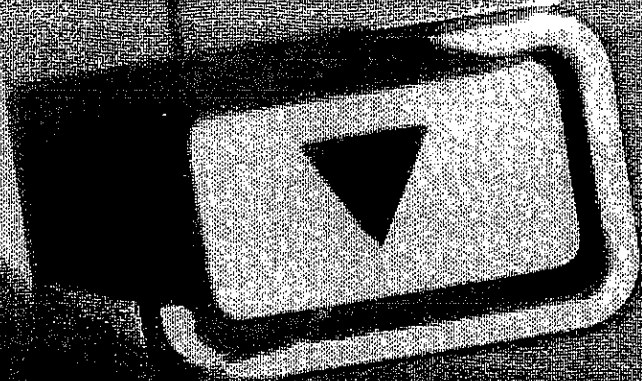

Chapter 5

Trigger Modes and Operations

Introduction to Trigger Modes

A *trigger* can generally be thought of as an event that starts the recording of data. You can use the front-panel controls of the HP 7090 to define a trigger by specifying conditions that must be met before triggering occurs. Three trigger modes — manual, external, and internal — are selectable. The following list describes how recording is triggered for each mode:

- *Manual trigger mode.* Recording is triggered when the **RECORD DIRECT** or **FILL BUFFER** pushbutton is pressed.
- *External trigger mode.* Recording is triggered when the **EXT TRIG** connector receives a low (logic 0) TTL level or contact closure to ground.
- *Internal trigger mode.* Recording is triggered when the amplitude and/or slope of the Channel 1 input signal fulfills conditions specified using the **TRIGGER LEVEL** and **TRIGGER WIDTH** setup conditions.

Post- or pre-trigger times may also be specified, allowing data to be recorded at a predetermined time after or before triggering. **POST TRIGGER** selections act as a delay — the selected delay time must elapse after receipt of a valid trigger before recording begins. Post-trigger times may be specified for either the buffered or the direct recording modes. (Post-trigger time may not be used, however, for the inside-window option of the internal trigger mode.)

PRE TRIGGER selections, on the other hand, apply only to buffered recordings, and are used to specify a time during which data is recorded immediately *before* the occurrence of a valid trigger. Because the recording of pre-trigger events is not possible unless recording has started before the trigger occurs, pre-trigger times can only be used for internally or externally triggered, buffered recordings. Pre-trigger time settings can be extremely useful for certain applications, as they allow you to capture data in the buffers that transpired immediately before the triggering event occurred.

All front-panel measurements are initiated by pressing **RECORD DIRECT** (for direct recordings) or **FILL BUFFER** (for buffered recordings). Before recording begins, however, two conditions must be satisfied: (1) the specified trigger must have occurred, and (2) the specified post-trigger time (if any) must have elapsed. The **TRIGGER SEARCH** indicator on the left front panel shows the status of these two conditions during a measurement.

Trigger Search Status

The **TRIGGER SEARCH** indicator is lit when a measurement has been initiated but the specified trigger has not been received — the indicator remains lit as long as the trigger search is active. (A trigger search is never necessary for manually triggered recordings, because initiating the measurement simultaneously supplies the trigger.) The **TRIGGER SEARCH** indicator turns off when the specified trigger has been found.

If you have specified a post-trigger time, the **TRIGGER SEARCH** indicator will begin blinking when the trigger occurs, and will continue blinking while the post-trigger time delay elapses. The indicator turns off when the post-trigger time has elapsed and recording begins. The following diagram illustrates the trigger search and post-trigger time-delay states.

Trigger Search and Post-Trigger Time-Delay States

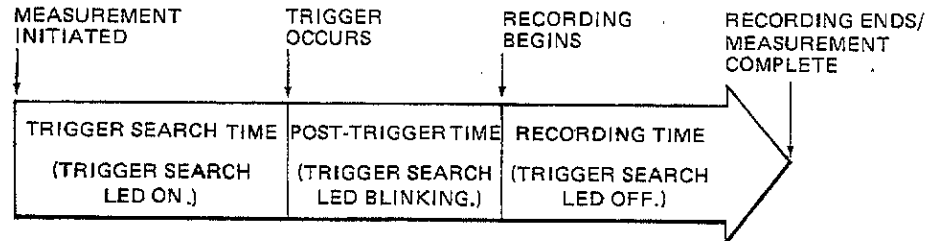

The Manual Trigger Mode

The manual trigger mode provides manual, front-panel (local) triggering of recordings. To select the manual trigger mode, use the trigger mode selector (shown below) to light the **MANUAL** indicator. Selecting the manual mode arms the HP 7090 so pressing **DIRECT RECORD** immediately triggers a direct recording; pressing **FILL BUFFER** immediately triggers a buffered recording. There is no trigger search for the manual recording mode.

A post-trigger time may be specified to begin recording at a predetermined time after the manual trigger. Pre-trigger time selections are ignored by the HP 7090 for the manual trigger mode.

The Trigger Mode Selector and Indicators

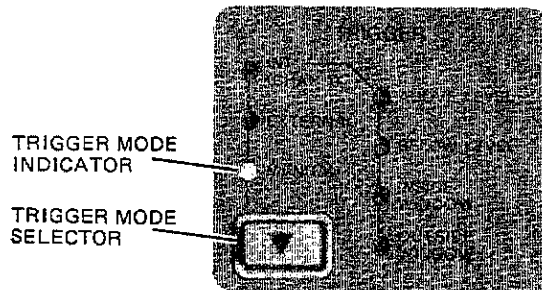

The External Trigger Mode

The external trigger mode provides external (remote) triggering of recordings. To select the external trigger mode, use the trigger mode selector to light the **EXTERNAL** indicator.

After selecting the external mode, a search for the external trigger is initiated by pressing **DIRECT RECORD** (for a direct recording) or **FILL BUFFER** (for a buffered recording). Recording can then be triggered by supplying a falling edge (logic 1 to 0) TTL level or contact closure to ground to the **EXT TRIG** (external trigger) connector on the right side panel.

Post- or pre-trigger time settings may be used for externally triggered, buffered recordings. However, only post-trigger time settings may be specified for externally triggered, direct recordings (pre-trigger selections are ignored).

The **EXT TRIG** connector accepts a male BNC connector, and is normally pulled high (logic 1 at 5-volt TTL level). After initiating a trigger search in the external trigger mode, a TTL-level transition from high to low (logic 1 to 0) applied to the **EXT TRIG** connector will trigger the recording. The recording may also be triggered by contact closure of the positive terminal of the connector to the connector's ground terminal.

The External Trigger Connector

The Internal Trigger Mode

With the internal trigger mode, you can specify signal voltage and slope requirements that must be met by the Channel 1 input to trigger a recording. After specifying the requirements and initiating a trigger search, the HP 7090 continuously monitors the Channel 1 input until the signal meets the requirements, at which time triggering occurs. Although triggering is via the Channel 1 input only, any of the channel inputs may be selected for recording in the direct recording mode, and all of the channel buffers are filled normally for the buffered recording mode.

Post- or pre-trigger time settings generally may be used for internally triggered, buffered recordings. Only post-trigger time settings, however, may be used for internally triggered direct recordings (pre-trigger times are ignored).

Four internal trigger options are available — above level, below level, outside window, and inside window. Select the desired option by using the trigger mode selector to light the appropriate indicator. The **TRIGGER LEVEL** and **TRIGGER WIDTH** setup conditions are then used to define the Channel 1 signal requirements, as described in the following sections.

Above-Level and Below-Level Triggering

The above-level option permits positive-slope triggering at a voltage specified by the **TRIGGER LEVEL** setup condition. The trigger is generated when the Channel 1 input signal rises to or above the trigger level value. Refer to the following diagram.

Examples of Above-Level Triggering

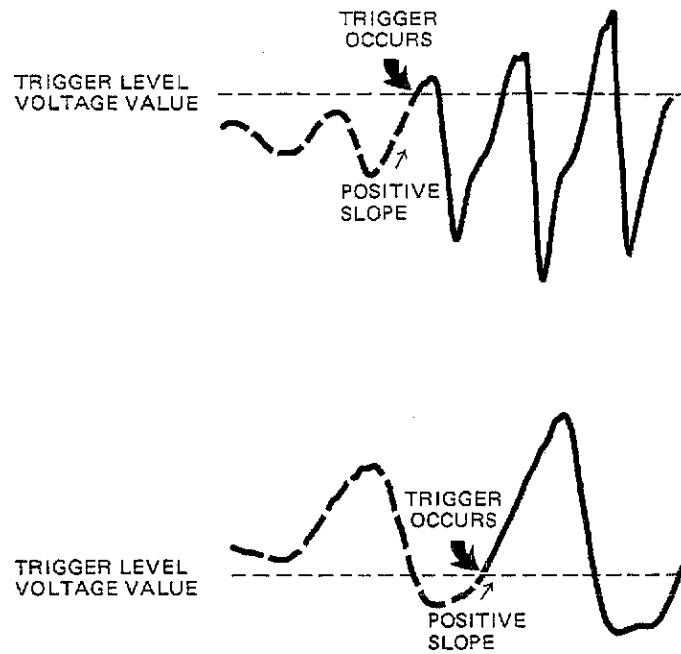

The below-level trigger option is similar to the above-level option, but it permits negative-slope triggering at the **TRIGGER LEVEL** voltage setting. The trigger is generated when the Channel 1 input signal falls to or below the trigger level value, as shown by the following diagram.

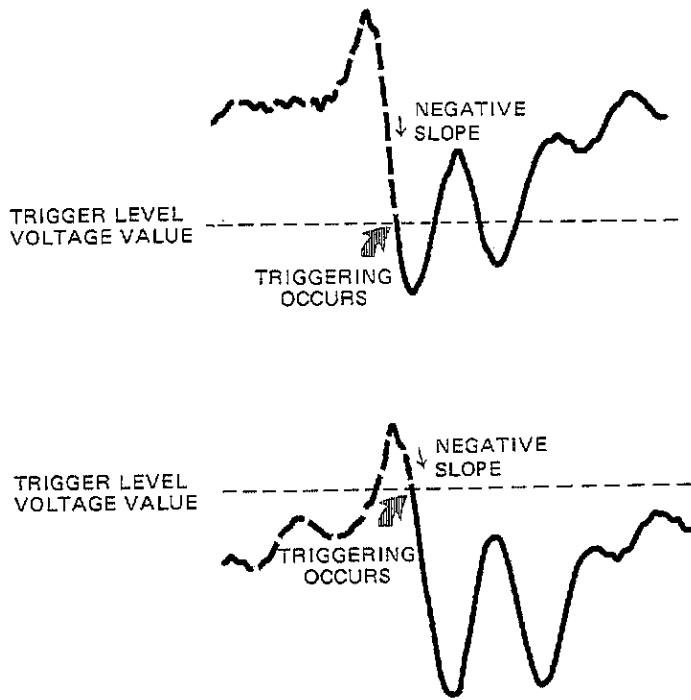

The Trigger Level Setup Condition

Default Value: 0.0 volts.

Range of Selectable Values: -200 to 200 volts.

The **TRIGGER LEVEL** setup condition is used to define the trigger level value for above- and below-level trigger options. It is also used to specify the center voltage of the trigger window used for the outside- and inside-window trigger options.

The **TRIGGER LEVEL** indicator will blink if you specify a **TRIGGER LEVEL** value that is above or below the specified voltage limits of the current recording area. If you initiate a trigger search while the indicator is blinking, the HP 7090 will internally set the trigger width value to the corresponding upper or lower voltage limit of the recording area. (The internally-set level will not be displayed, however.)

The outside- (and inside-) window option enables you to define a trigger window having an upper and lower voltage limit. The window is centered about the specified **TRIGGER LEVEL** setup condition value. The vertical width of the window is specified by a second setup condition value, the **TRIGGER WIDTH**. Refer to the following illustration, which shows a trigger window defined by a trigger level value of 10 volts and a trigger width value of 2 volts.

Outside-Window Triggering

A Trigger Window

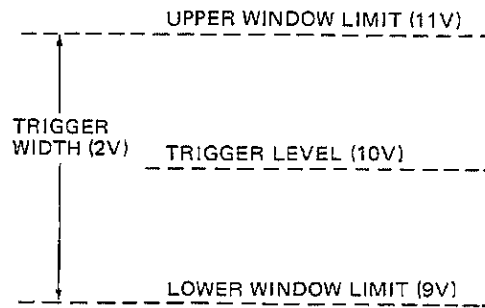

A trigger is generated in the internal, outside-window mode when the Channel 1 input signal equals or falls outside of either of the trigger window limits. If the input signal voltage is outside of (or equal to) the specified limits when you initiate the trigger search, triggering occurs immediately. Refer to the following illustration.

Examples of Outside-Window Triggering

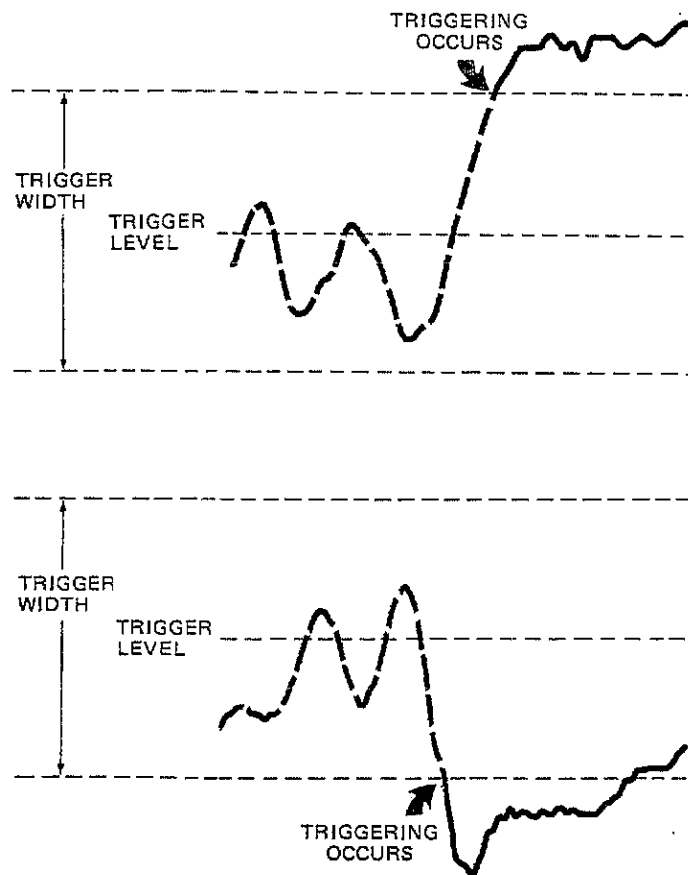

The Trigger Width Setup Condition

Default Value: 0.0 volts.

Range of Selectable Values: 0.0 to 200 volts.

The **TRIGGER WIDTH** setup condition is used to define the trigger window width for the inside- and outside-window trigger options. The **TRIGGER WIDTH** indicator will blink if you specify a **TRIGGER WIDTH** value that is greater than $2 \times \text{RANGE 1}$. If you initiate a trigger search while the indicator is blinking, the HP 7090 will internally set the trigger width value to $2 \times \text{RANGE 1}$. (The internally set value will not be displayed, however.)

Inside-Window Triggering

The inside-window option uses a window defined by the **TRIGGER LEVEL** and **TRIGGER WIDTH** setup conditions, as described for the outside-window option. After you initiate a trigger search, the Channel 1 input signal is monitored and compared with the trigger window limits.

For the direct recording mode, triggering occurs when the Channel 1 input signal equals or falls inside the trigger window limits. If the input voltage is inside of (or equal to) the specified limits when you press **DIRECT RECORD**, triggering occurs immediately. Refer to the following illustration. Post-trigger time delays may be specified; however, pre-trigger time selections are ignored.

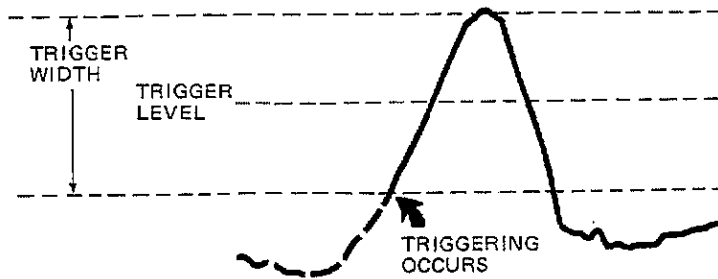

*Inside-Window Triggering
(Direct Recording Mode)*

For the buffered recording mode, the recording is completed and triggering occurs when *1000 consecutive data samples* have occurred inside (or upon) the window limits. This is shown by the following illustration. The buffers start to fill when a signal sample falls inside (or upon) the window limits. Filling then continues normally *unless* a sample falls *outside* the window — if this occurs, the search for an inside-window sample begins again. This cycle repeats until 1000 consecutive data samples have fallen inside the window, allowing the buffers to fill completely. The buffer contents are then frozen and the recording is terminated.

**Inside-Window Triggering
(Buffered Recording Mode)**

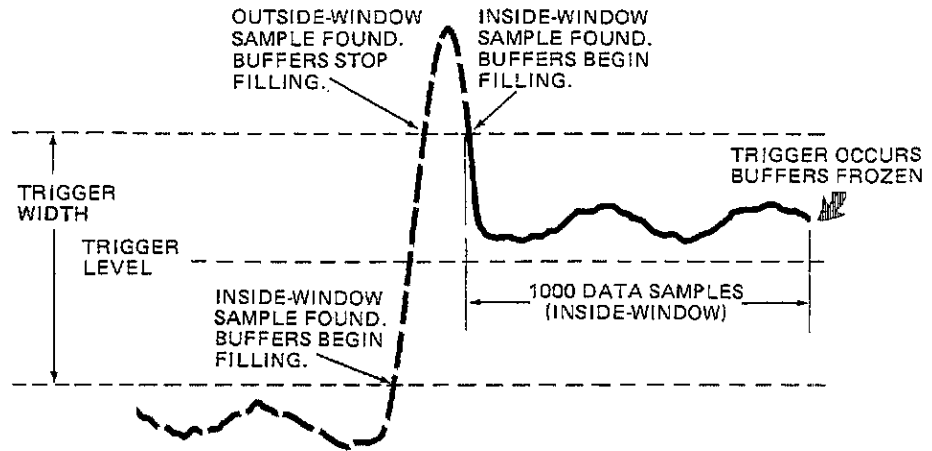

Because the buffers contents are filled following the required sequence of inside-window data, post-trigger times are not applicable and, if specified for a buffered recording, are ignored by the HP 7090. Pre-trigger times may be specified, however.

If you select a pre-trigger time, the required number of consecutive inside-window samples is reduced accordingly, as illustrated below. Pre-trigger data consists of samples that immediately precede the buffered sequence of inside-window samples. Note that the buffers are filled when the Channel 1 input signal has remained inside the window for a time equal to **TOTAL TIME — PRE TRIGGER** time.

**Buffered Inside-Window
and Pre-Trigger Data**

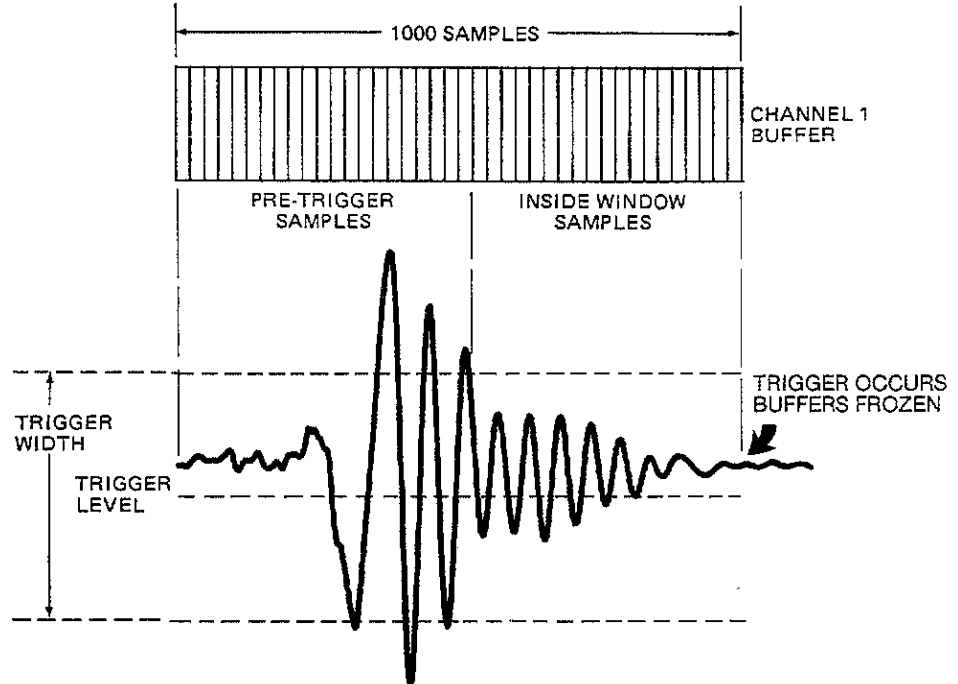

Triggering

Post- and Pre-Trigger Time

Post- and pre-trigger time selections can be extremely useful for certain applications. For example, by selecting an appropriate post-trigger time, you can set the HP 7090 to begin recording data at a specified time after the occurrence of a trigger. Pre-trigger times can be used to capture data in the buffers for events that occurred immediately *before* a selected triggering-event. The following section describes the post- and pre-trigger setup condition used to select post- or pre-trigger times.

The Post Trigger/Pre Trigger Setup Condition

Default Value: 0.0 seconds.

Range of Selectable Values: 0.01 second to 24 hours (post-trigger).
-0.01 second to -24 hours (pre-trigger).

Pre-trigger selections displayed on the LCD are preceded by a minus (-) sign. The selectable time increments for pre- and post-time settings are dependent upon the **TOTAL TIME** setting — smaller total time settings allow smaller selectable time increments.

For the default setting of 0.0 seconds (no pre- or post-trigger time) recording begins the moment a valid trigger is received. However, all trigger modes (except internal with the inside-window option) are subject to post-trigger time selections. *Post-trigger time* is the amount of time delay that must elapse after triggering before recording occurs.

Pre-trigger time, on the other hand, applies only to internally or externally triggered, buffered recordings. A pre-trigger time value specifies what portion of **TOTAL TIME** is to be used for storing digitized input signal data occurring immediately before the trigger. Refer to the following illustration.

With a pre-trigger time specified, the buffers begin filling as soon as you press **FILL BUFFER**. They continue filling until the specified pre-trigger time has elapsed, at which time the buffer contents are continuously updated until the valid trigger arrives. Upon arrival of the trigger, the data currently captured in the buffers (representing the pre-trigger time) is frozen, and the remaining buffer space is filled. If the trigger occurs *before* the specified pre-trigger time has elapsed, the pre-trigger time is cut short and the buffers are allowed to fill.

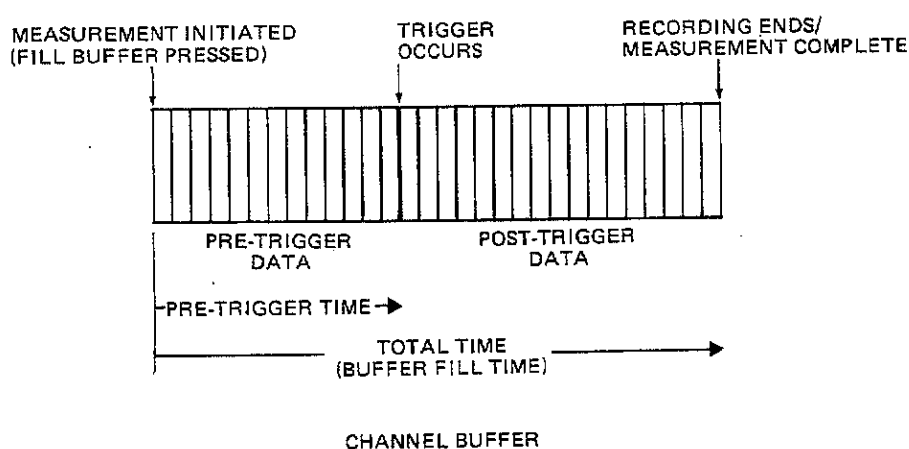

Capturing Pre-Trigger Data in a Buffer

The selected pre-trigger value should not exceed the value specified for total time. Exceeding the total time causes the **POST TRIGGER/PRE TRIGGER** indicator to blink, and the HP 7090 will internally set the pre-trigger value to your specified **TOTAL TIME** value. (The reset value is not displayed on the LCD, however.)

00000

9:00

5:55

RANGE TIME

OFF-TIG:

TOT-TIGER:

PR-TIGGER:

TR

00000

Chapter 6

Labeling Functions and Operations

Annotating Measurements

The HP 7090 front-panel controls can be used to label measurement information directly onto your hardcopy plots. In addition to the **PEN POSITION** labeling function described in Chapter 4, the following annotations are available:

- The current time and date.
- The time at which a trigger occurred (trigger time).
- The front-panel measurement setup conditions.

When interfaced with a host computer or controller, the HP 7090 can also be used as a digital plotter to produce custom labeling or other types of graphics output. Refer to the Interfacing and Programming Manual for details. Because certain instructions issued to the HP 7090 via the interface have an affect on the performance of front-panel labeling operations, this chapter assumes that no such I/O instructions have been issued.

Any available color and width pen may be used for labels (a 0.3-mm black pen is suggested), and labeling always begins at the current pen position. Use the pen cursor controls to position the selected pen before invoking a label function. The pen should be positioned so that the entire label can be printed within the hard-clip limits of the paper, otherwise the label will be clipped. The label area required for each type of label is provided in the following sections.

NOTE: Once invoked, label functions are carried out until completed and cannot be terminated using the **STOP** pushbutton. Therefore, always position labels carefully before invoking label functions. ■

Before printing the time and date label, select a pen and position it so that the label will fit within the hard-clip limits. The area required for the time and date label in relationship to the initial pen position is shown by the following illustration.

Printing the Time and Date

Area Required for the Time and Date, and Trigger Time Labels.
 The default label dimensions are shown for A/A4 paper and (in parentheses) B/A3 paper.



To invoke the label function, press (SHIFT) PRINT TIME. (Be certain that "SHIFT" is displayed on the LCD before pressing the PRINT TIME push-button.) The HP 7090 will access its real-time clock and print the current time and date using the 24-hour clock notation shown below. (If you need to set the real-time clock, refer to "Setting the Real-Time Clock" in Chapter 2.)

A Time and Date Label.
 The label shown here is actual size for A/A4 paper.

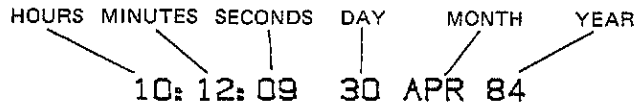

Printing the Trigger Time

Whenever the HP 7090 receives a valid trigger (including a manual trigger), the time of the trigger occurrence is stored in volatile memory. This recorded trigger time can be labeled on the plotted measurement. Before printing a trigger time label, select a pen and position it so that the resulting label will fit within the hard-clip limits of the paper. The area required for the trigger time label is the same as that for the time and date label (refer to the preceding section).

To print the trigger time, press (SHIFT) PRINT TRIG TIME. (Be certain that "SHIFT" is displayed on the LCD before pressing the PRINT TRIG TIME push-button.) The HP 7090 will print the time at which the most recent trigger was received, as shown below. (If no trigger time has been received since power-up, the HP 7090 will print the time of power-up.) A given trigger time must be labeled before performing a subsequent measurement, as the trigger time label is updated whenever a trigger is received.

A Trigger Time Label.
 The label shown here is actual size for A/A4 paper.

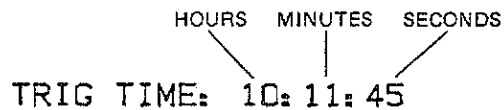

Labeling Setup Conditions

The front-panel setup conditions used for a measurement can be labeled on the hardcopy plot. A setup conditions label includes the range and offset settings for all three input channels, the total time setting, post- or pre-trigger time settings, the trigger mode selection, and trigger level and width (if internal triggering was selected).

Before invoking the labeling function, select a pen and position it so that the intended label will fit within the hard-clip limits. The area required for a typical setup conditions label in relationship to the initial pen position is

shown below. Note that the label consists of five lines of annotation, so allow enough labeling space below the pen position.

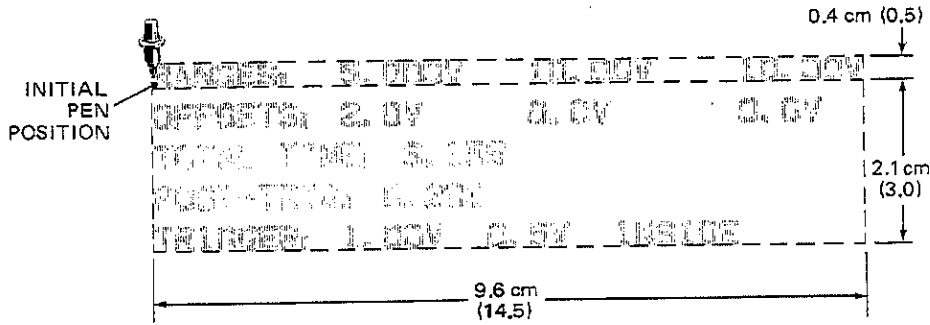

Area Required for the Setup Conditions Label.
 The default label dimensions are shown for for A/A4 paper and (in parentheses) B/A3 paper.

To label the current setup conditions, press (SHIFT) LABEL. (Be certain that "SHIFT" is displayed on the LCD before pressing the LABEL pushbutton.) A given set of conditions should be labeled before any conditions are changed, as the setup conditions label is updated any time you use the control wheel to select a new setup condition.

A typical setup conditions label is shown below. Trigger level and width values are labeled only when the internal triggering mode is selected. The below-level triggering option is denoted as -LEVEL, whereas the above-level option is denoted as +LEVEL.

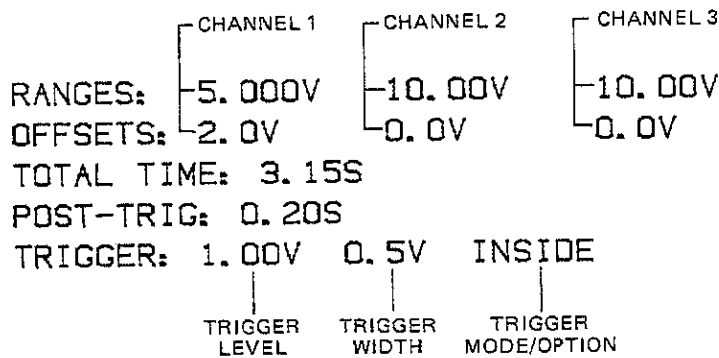

A Setup Conditions Label.
 The label shown here is actual size for A/A4 paper.

Positioning Multiple Labels

After printing any of the labels described previously, the HP 7090 performs a carriage return and line feed, automatically positioning the pen so that invoking a subsequent label function will place the label directly beneath the first. This feature enables you to neatly position labels without repositioning the pen after each label is drawn, as shown by the following illustration — the complete set of labels was created by initially positioning the pen and then invoking each label function.

Multiple Labels

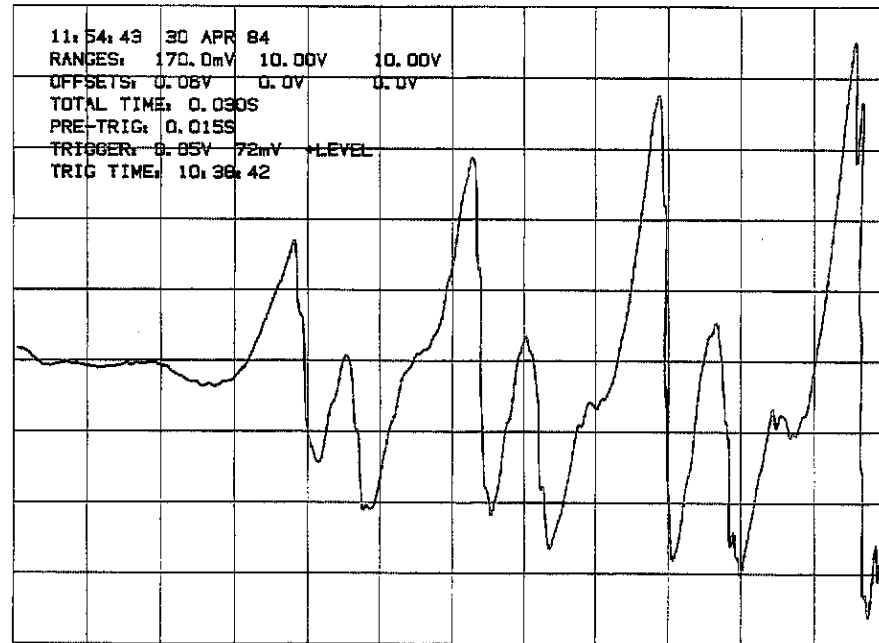

Label Character Size

The dimensions used for label characters are based upon the relative positions of two movable points, *P1* and *P2*. Following power-up or front-panel initialization, *P1* and *P2* are located at their default positions, as shown by the following diagrams. (Default *P1* is coincident with the default zero point; default *P2* is coincident with the default full-scale point.)

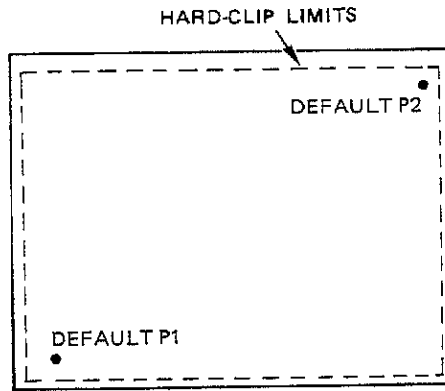
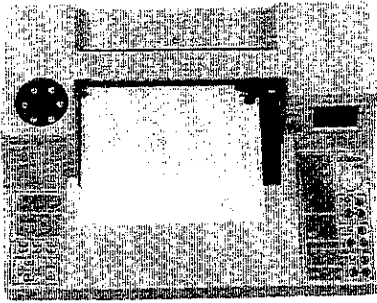

Default Locations of P1 and P2 (A/A4 Paper)

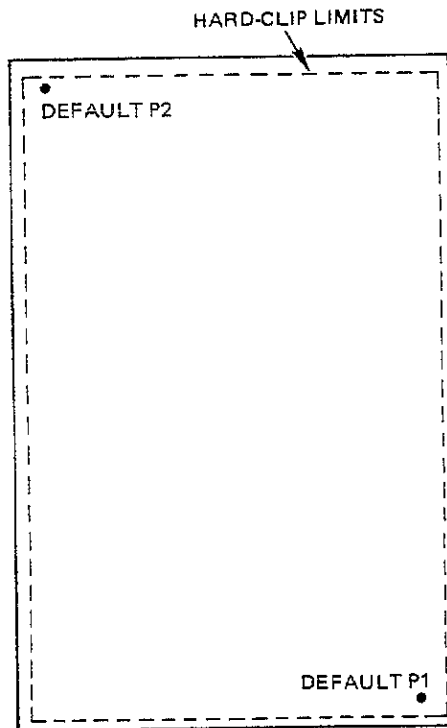
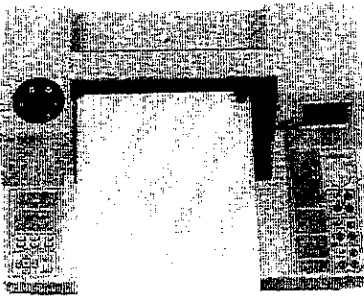

Default Locations of P1 and P2 (B/A3 Paper)

The width of the characters used for labels is 0.75% of the horizontal distance between P1 and P2. Similarly, the height of label characters is 1.5% of

the vertical distance between P1 and P2. These proportions, when applied to default P1 and P2, result in the default character sizes shown below (actual size).

Default Character Sizes

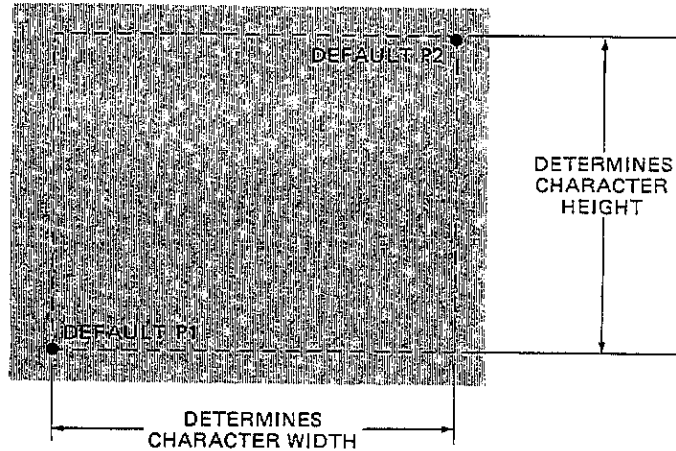

TRIG TIME: 12: 04: 46

(A/A4 PAPER)

TRIG TIME: 12: 04: 46

(B/A3 PAPER)

Because the vertical and horizontal distances between P1 and P2 determine character size, P1 and P2 can be moved from their default positions to change default character size. This procedure, described in the following paragraphs, is analogous to the positioning of the zero and full-scale points to change the size of the recording area.

Changing Default Character Size

The default characters are compatible in size with the dimensions of the default recording area. For applications requiring smaller recording areas, however, you may want to reduce the character size accordingly.

Because the default proportions (height-to-width ratio) of the label characters are preset to provide visually appealing characters, the simplest method of reducing character size without distorting the characters is to maintain the default height-to-width ratio, while shortening the vertical and horizontal distances between P1 and P2. This can be achieved by moving P2 towards P1 along the imaginary diagonal between P1 and P2. (Instructions on how to move P1 and P2 are provided in the next section.) The following illustration demonstrates how moving P2 along the P1-P2 diagonal affects character size. Note that character size reduction is directly proportional to reduction of the distance P1-P2.

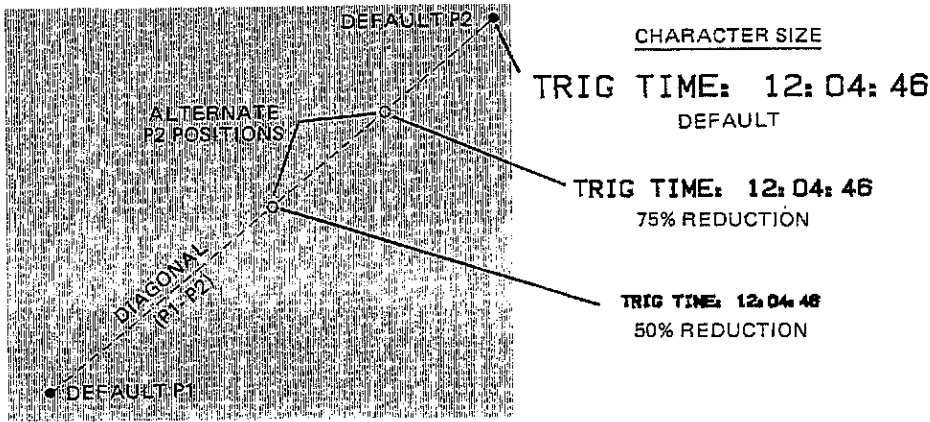

In addition to reduction, default character size can be enlarged slightly by moving P1 and P2 to their respective corners of the hard-clip limits. Doing so increases the length of P1-P2 to its maximum. Positioning P2 below the P1-P2 diagonal will result in short, wide characters, due to the change in the height-to-width ratio. Similarly, positioning P2 above the diagonal will create tall, narrow characters. Extreme changes in either the vertical or horizontal distances between P1 and P2, however, will result in illegible or hard-to-read characters.

The P1 and P2 scaling points are moved in a manner similar to moving the zero and full-scale points. To move P2, press (SHIFT) P2 to invoke the P2 positioning function. The pen will move to a point above the current P2 location. (Be certain "SHIFT" is displayed *before* pressing P2, otherwise the full-scale point will be moved instead of P2.)

Positioning P1 and P2

The **FULL SCALE/P2** indicator remains lit while the P2 positioning function is in effect, indicating that the pen cursor controls can be used to position P2. To reduce character size, for example, use the pen cursor controls to move P2 towards P1 along the diagonal P1-P2. (The final location of P2 does not have to lie exactly upon P1-P2, an approximate location will do.) After positioning P2, exit the function by pressing the P2 pushbutton. This turns off the indicator, establishes the new P2 position, and allows you to use the pen cursor controls without affecting P2.

NOTE: Always exit the P2 positioning function to prevent accidental repositioning of P2. ■

Although moving only P2 will accomplish most required character size modifications, P1 can also be repositioned. To position P1, press (SHIFT) P1. The pen will move to the current P1 position, and the **ZERO/P1** indicator will light. (Be certain that "SHIFT" appears on the LCD *before* pressing P1, otherwise the zero point will be moved instead of P1.)

As long as the P1 positioning function is in effect, as shown by the lit **ZERO/P1** indicator, the pen cursor controls can be used to move the pen to a desired P1 location. After you have positioned the pen, exit the function by

pressing the P1 pushbutton. This turns off the indicator and establishes the new P1 position, allowing the pen cursor pushbuttons to be used without affecting P1.

NOTE: Always exit the P1 positioning function to prevent accidental repositioning of P1. ■

The position of P2 is automatically moved when P1 is moved so that the vertical and horizontal distances between P1 and P2 remain constant. Therefore, if you want to position both P1 and P2, always move P1 first. (If moving P1 pushes P2 against any of the hard-clip limits, either or both coordinates of P2 are set to those of the hard clip-limits.)

Rotation of Labels

Using the rotate function (described under "Rotating the Recording Area" in Chapter 3) to rotate recording areas also rotates the orientation of printed labels. This is done so that all labels are printed upright in relation to the recording area's X-axis. Label rotation is the result of a change in the default positions of P1 and P2. The following illustrations show the rotated locations of P1 and P2.

*Rotated Locations of
Default P1 and P2
(A/A4 Paper)*

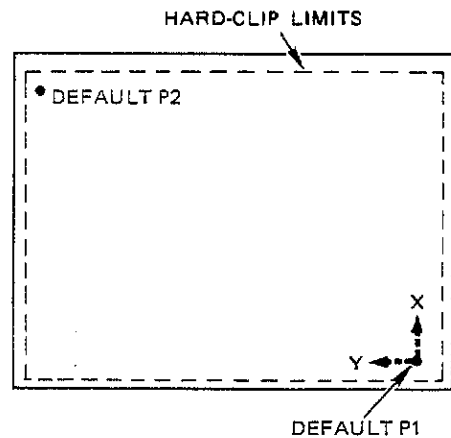
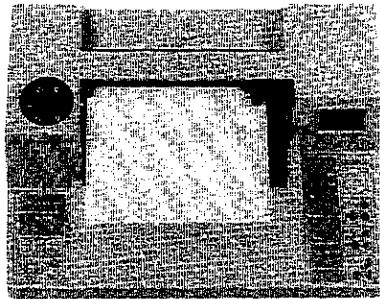

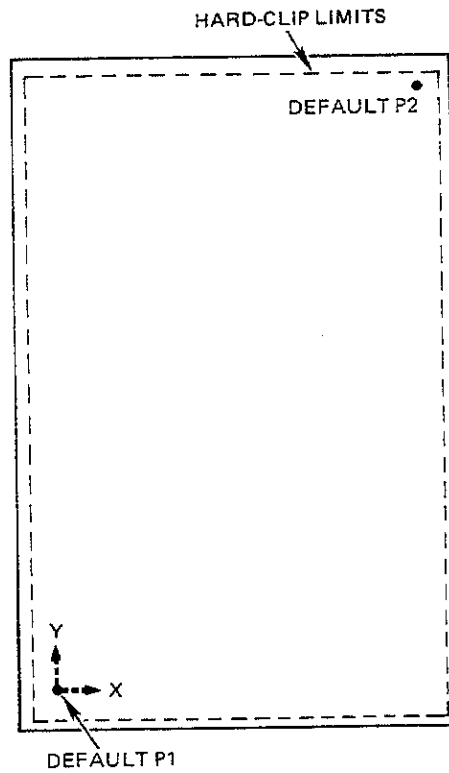
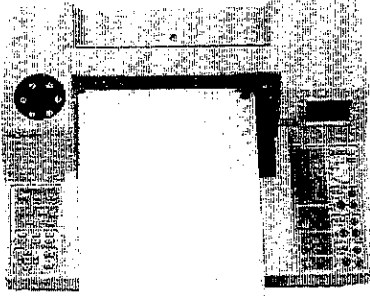

*Rotated Locations of
Default P1 and P2
(B/A3 Paper)*

As a result of rotation, the normal height-to-width ratio is changed so that the height of rotated characters is slightly elongated, as shown below. If you want to shorten the characters, use the P2 positioning function to reduce the vertical distance between P1 and P2.

TRIG TIME: 12:04:46

ACTUAL SIZE,
(A/A4 PAPER)

TRIG TIME: 12:04:46

ACTUAL SIZE,
(B/A3 PAPER)

*Rotated Default
Character Size*

Appendix A

Default Conditions and Values

The following values and front-panel selections are assumed by the HP 7090 following power-up or front-panel initialization. In addition, P1, P2, and the zero and full-scale points are located at their default positions.

Condition	Value
Setup conditions	
Range (Channels 1, 2, and 3)	10.0 volts
Offset (Channels 1, 2, and 3)	0.0 volts
Grid divisions, X-axis	25 (A/A4-size paper) 38 (B/A3-size paper)
Grid divisions, Y-axis	18 (A/A4-size paper) 25 (B/A3-size paper)
Total time	1.0 second
Post- or pre-trigger time	0.0 seconds
Trigger level	0.0 volts
Trigger width	0.0 volts
Front-panel selections	
Trigger mode selection	manual
Channel selections	Channel 1 vs time
Setup conditions selection	Channel 1 range
Quadrant selection (for grid)	Quadrant 1

Appendix B

Specifications*

The following provides a summary of the functioning characteristics and electrical accuracy of the HP 7090:

Inputs

Number of channels	3
Type of input	floating, guarded
Sensitivity	5 mV to 100 V full scale
Zero offset	± 2 full scale or ± 100 V maximum
Input impedance (NOMINAL)	1 M Ω , shunted by 45 pf
Maximum input voltage	200 V, dc or peak
Maximum source resistance	10 k Ω
Common mode rejection ratio	140 dB dc; 100 dB ac @ 60 Hz with 1 k Ω unbalance in LOW terminal on most sensitive range at 25° C, 50% RH

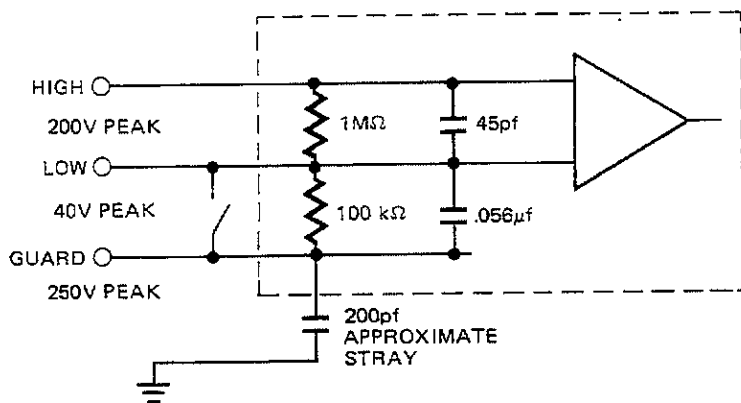

Input Terminal Schematic

Timebase

Range:	
Buffer mode	30 milliseconds to 24 hours
Direct record mode	1 second to 24 hours
Accuracy	$\pm 0.1\%$

*Specifications describe the instrument's warranted performance. Supplemental characteristics are intended to provide information useful in applying the instrument by giving typical or nominal, but not warranted, performance parameters.

Dynamic Performance

Slewing speed (NOMINAL):
 Direct record mode 127 cm/s (50 in./s)
 Plotting mode 75 cm/s (30 in./s)

Acceleration (NOMINAL) 196 m/s² (2 g's) constant

Bandwidth (-3 dB) 3 kHz for all full-scale ranges
 ≥ 20 mV
 2.6 kHz for all full-scale ranges
 < 20 mV

Peak capture 250 μs at fastest timebase range

Memory Per Channel

Size 1000 words

Resolution 12 bits

Trigger Characteristics

Internal trigger:
 Inside or outside window
 Above or below level, selectable over the full-scale range in 1.0% increments (NOMINAL)
 Source, channel 1

External trigger:
 BNC connector, TTL level or contact closure to ground

Manual trigger:
 Available from front-panel controls or I/O

Display:
 Up to 100% pre-trigger; up to 24-hour post-trigger delay after trigger before measurement start

Electrical Accuracy Tables**

*Electrical Accuracy
 @ 25 Degrees C*

Range	Constant Inaccuracy	Percent Reading Inaccuracy
5 mV	±0.013 mV	±0.055%
10 mV	±0.021 mV	
20 mV	±0.036 mV	
50 mV	±0.082 mV	
100 mV	±0.158 mV	
200 mV	±0.306 mV	
500 mV	±0.760 mV	
1 V	±0.0015 V	
2 V	±0.0030 V	
5 V	±0.0076 V	
10 V	±0.0152 V	
20 V	±0.0304 V	
50 V	±0.0760 V	
100 V	±0.1520 V	

** Accuracy specifications are for |offset| < full-scale range and a signal source resistance ≤ 10 kΩ.

Electrical Accuracy Tables (Continued)

Range	Constant Inaccuracy Per Degree C	Percent Reading Inaccuracy Per Degree C
5 mV	±0.0022 mV	±0.01%
10 mV	±0.0028 mV	
20 mV	±0.0040 mV	
50 mV	±0.0076 mV	
100 mV	±0.0136 mV	
200 mV	±0.0256 mV	
500 mV	±0.0616 mV	
1 V	±0.0001 V	
2 V	±0.0002 V	
5 V	±0.0006 V	
10 V	±0.0012 V	
20 V	±0.0024 V	
50 V	±0.0060 V	
100 V	±0.0120 V	

*Electrical Accuracy
Temperature Coefficient
from 25 Degrees C*

Specifications

Range	Constant Inaccuracy	Percent Reading Inaccuracy
5 mV	±6	±0.055%
10 mV	±5	
20 mV	±4	
50 mV and up	±3	

*Electrical Accuracy
@ 25 Degrees C
(A/D Converter Counts)*

Range	Constant Inaccuracy	Percent Reading Inaccuracy
5 mV	±0.88	±0.01%
10 mV	±0.56	
20 mV	±0.40	
50 mV and up	±0.30	

*Electrical Accuracy
Temperature Coefficient
from 25 Degrees C
(A/D Converter Counts)*

Appendix C

Supplemental Characteristics

Writing System

6-pen carousel with automatic pen capping
Fiber-tip pens for paper or transparencies

Digital Plotting

Intelligence:

Over 40 HP-GL instructions

Five built-in character sets including

- ANSI ASCII
- HP 9825
- French/German
- Scandinavian
- Spanish/Latin American

Front-panel controls:

P1, P2; pen position cursors; pen selection

Interface modes (user-selectable):

Listen only; listen/talk

Media

Types:

Paper

Overhead transparency film

Paper sizes (switch-selectable):

210 × 297 mm (ISO A4)	8.5 × 11 in. (ANSI A)
297 × 420 mm (ISO A3)	11 × 17 in. (ANSI B)

Programming

HP-IB control of all recorder and plotter functions

Software lockable front panel

Scope Output

Allows use of X-Y oscilloscope to preview buffer contents

Connectors: two BNC, vertical and horizontal

Output: -10 V to +10 V (0 V corresponds to origin on chart); refreshed every 15 ms

External Pen Control

BNC connector, TTL level or contact closure to ground

Analog-to-digital Conversion

Maximum sampling rate: 33.3k sample/s

Maximum streaming rate over HP-IB:	ASCII	Binary
1 channel	167/s	500/s
1 channel plus trigger	143/s	333/s
3 channels	59/s	167/s
3 channels plus trigger	59/s	167/s

Real-time Clock

Functions: second, minute, hour, day, year

Controls: front-panel set, battery backup

Environmental

Operating humidity: 5-95% (at 40° C)

Operating temperature: 0-55° C

Storage temperature: -40-75° C

Power Requirements

Source: 100, 120, 220, 240 V~-10%, +5%

Frequency: 48-66 Hz

Consumption: 140 W

Size

Height: 205.5 mm (8.1 in.)

Width: 575.0 mm (22.6 in.)

Depth: 465 mm (18.3 in.)

Weight

Net: 15.7 kg (34.5 lbs)

Shipping: approximately 23.6 kg (52 lbs)

Appendix **D**

Accessories Available

The following items are available for your HP 7090A Measurement Plotting System and can be ordered from Hewlett-Packard using the appropriate part number. For information on available pen and media supplies, refer either to the Computer User's Catalog or to the supplies brochure shipped with your HP 7090.

Item	Part Number
Service Manual	07090-90000
Dust cover	92259D
HP 17090A, B, or C measurement graphics software Option 630, 3.5-in. disc Option 655, 5.25-in. disc	—

The following table lists the operating system, memory, and equipment that are needed to use the HP 17090 software with the HP 7090.

HP 17090 Version	Operating System	Available RAM ¹		Applicable HP 9000 Models
		Minimum	Optimum	
A	BASIC 2.0	235K	470K	HP 216 HP 226 HP 236 HP 220 ²
B	BASIC 3.0 w/DISC ³ , GRAPH, HPIB, and IO	216K	433K	HP 216 HP 226 HP 236 HP 220 ²
C	BASIC 4.0/4.03 w/CRTB ⁴ , DISC ³ , GRAPH, GRAPHX, HPIB, IO, and KBD	245K	470K	HP 216 HP 217 ⁵ HP 226 HP 236 HP 220 ⁵ HP 237 ⁵ Series 300 (notes 6, 7, 8)

- 1Memory required after loading BASIC and all necessary binary files. With minimum RAM, short delays will be encountered when software subsystems are swapped in memory.
- 2Applicable when equipped with an HP 98203A/B keyboard.
- 3DISC is required only when using external disc drives. Other binaries should be loaded if required by the user's system.
- 4Substitute CRTA for CRTB when the HP 98546A display compatibility interface is used.
- 5Applicable when equipped with BASIC 4.03 and an HP 98203C keyboard.
- 6BASIC 4.03 is required when the computer is equipped with an HP 98203C keyboard.
- 7The HP 46083A knob is required when the computer is equipped with either an HP 46020A or 46021A keyboard.
- 8The HP 98546A display compatibility interface is required when the computer is equipped with a single-plane (monochrome) bit-mapped display.

**Want a complete list of Hewlett-Packard
supplies and accessories?**

Order the Hewlett-Packard Computer User's Catalog
(5953-2450) from your local HP Sales and Support Office,
or by writing:

Hewlett-Packard
San Diego Division
16399 West Bernardo Drive
San Diego, CA 92127-1899

In a hurry? Your fastest way to receive products is to call



HP's Direct Order telephone number:
800-538-8787 or
408-738-4133 in California, Alaska, Hawaii

Subject Index

a

Above-Level Triggering	5-4 through 5-5
Accessories Available	D-1
Accessories Supplied	1-2
A/D Converter	2-1, 4-4
Address Switches	2-5
Air Filter, Cleaning the	1-6
Analog Input Signals, Connecting	3-22
Analog-to-Digital Converter, <i>See</i> A/D Converter	
Annotating Measurements	6-1
ANSI Paper Sizes, <i>See</i> Paper Sizes	

b

Battery Replacement	1-6
Below-Level Triggering	5-4 through 5-5
Buffer, Defined	4-4
Buffer Filled Indicator	2-7, 4-7
Buffered Recording Mode	2-2, 4-7 through 4-8
Buffered Recording	
Defined	2-2
Performing a	4-7 through 4-8

c

Carousel, Pen	
Cleaning	1-5
Loading	2-10
Channel Buffer, <i>See</i> Buffer	
Channel Input Signals, <i>See</i> Analog Input Signals	
Channel Select Controls, Using the	3-3
Channel Selection	3-2 through 3-3
Character Size	6-4 through 6-6
Cleaning the Instrument	1-5 through 1-6
Clipping	3-4 through 3-5
Clock, Setting the Real-Time	2-18 through 2-19
Confidence Test	2-13 through 2-14
Control Wheel, Using the	2-16
Controls, Summary of	
Left Front Panel	2-7 through 2-9
Right Front Panel	2-5 through 2-7

d

Data Display Selector	2-7, 3-24, 4-8
Data-Display Function	
Input	2-3, 3-24 through 3-25
Pen Position	2-3, 4-8 through 4-10
Default	
Character Size	6-6
Conditions, Table of	A-1
Recording Area	3-4
Defining the Axes, <i>See</i> Channel Selection	

**Subject
Index
(Continued)**

d (Continued)

- Demonstration Plot 2-13 through 2-14
- Digital Voltmeter, *See* Data-Display Function, Input
- DIP Switches 2-5
- Direct Recording Mode 2-2, 4-1
- Direct Recording
 - Defined 2-2
 - Versus Chan3, Performing a 4-3 through 4-4
 - Versus Time, Performing a 4-1 through 4-2
- Displaying Buffered Data 4-8 through 4-10
- Displaying Input Voltages 3-24 through 3-25

e

- Error Codes 2-12
- External Pen Connector 4-4
- External Trigger Connector 5-3
- External Trigger Mode 5-3

f

- Fill Buffer Button 4-7
- Full Scale Button 3-7
- Full-Scale Point
 - Default 3-6
 - Defined 3-4
 - Positioning the 3-7
 - Rotated 3-20 through 3-21
- Fuse, Replacing the 1-3

g

- Grid Button 3-19
- Grid Divisions Setup Condition 3-17 through 3-18
- Grid, Drawing the 3-18 through 3-19
- Ground Connection Lug 3-23
- Grounding Requirements 1-5
- Guard, Connecting and External 3-22 through 3-33
- Guard Switch, Using the 3-22 through 3-33
- Guard Terminal 3-22

h

- HP-IB Bus Connector 2-5
- Hard-Clip Limits, Defined 3-4

i

- ISO Paper Sizes, *See* Paper Sizes
- Initialize Button 2-15
- Input Voltages, Displaying 3-24 through 3-25
- Inside-Window Triggering 5-7 through 5-8
- Internal Trigger Mode 5-3

Subject Index

(Continued)

I

Label Button 6-3
Label Character Size, *See* Character Size
Labeling
 Buffered Data Points 4-8 through 4-10
 Setup Conditions 6-2 through 6-3
 Time and Date 6-1 through 6-2
 Trigger Time 6-2
Local Button 2-6

m

Maintenance, Instrument 1-5 through 1-6
Manual Trigger Mode 5-2
Medium, Choosing the Correct 2-9

O

Offset Equation 3-13
Offset Restrictions 3-15 through 3-16
Offset Setup Condition 3-13
Offset, Selecting the, 3-13 through 3-14
Oscilloscope, Connecting an 4-11
Outside-Window Triggering 5-5 through 5-6
Overhead Transparencies, *See* Transparency Film
Overflow Condition, Causes of 3-24
Overflow Indicator 3-24

p

P1 Button 6-7 through 6-8
P2 Button 6-8
Paper Format Switch, Setting the 2-11
Paper Size Button 2-12
Paper
 Sizes 2-11
 Loading 2-12 through 2-13
Pen Cursor Controls 2-18
Pen Down Button 2-18
Pen Select Buttons 2-17
Pen Up Button 2-18
Pens
 Choosing the Correct Type 2-9
 Loading 2-10
 Storing 2-17 through 2-18
Pinch Wheel Position, Changing the 2-12
Plot Buffer Button 4-8
Plot Buffer Function 2-2
Plotting the Buffer(s) 4-8
Post-Trigger/Pre-Trigger Setup Condition 5-9 through 5-10
Post-Trigger Time, Defined 5-9
Power Configurations 1-3
Power Cord 1-3 through 1-4
Power Requirements 1-2 through 1-3

Subject Index (Continued)

p (Continued)

- Power-Up Initialization 2-11
- Preparing a Recording Area 3-1 through 3-22
- Pre-Trigger Time, Defined 5-9
- Print Time Button 6-2
- Print Trigger Time Button 6-2
- Printing
 - Buffered Data Points 4-8 through 4-10
 - Setup Conditions 6-2 through 6-3
 - Time and Date 6-1 through 6-2
 - Trigger Time 6-2

q

- Quadrants, Effect of Zero and Full Scale on 3-4
- Quadrant Grid, Specifying the 3-17
- Quadrants, Selecting for Grid 3-18 through 3-19

r

- Range, Selecting the 3-11 through 3-12
- Range Equation 3-11
- Range Setup Condition 3-9 through 3-11
- Real-Time Clock, Setting the 2-18 through 2-19
- Record Direct Button 4-2, 4-3
- Recording Area
 - Defined 3-1
 - Preparing a 3-1 through 3-22
 - Rotating the 3-20 through 3-22
 - Scaling the 3-8 through 3-16
- Restore Setup Button 2-15 through 2-16
- Rotating Labels 6-8 through 6-9
- Rotating the Recording Area 3-20 through 3-22

s

- Sample Rate
 - Effect of Total Time on 4-6
 - Minimum 4-6
- Save Setup Button 2-15 through 2-16
- Scaling
 - Label Character Size 6-4 through 6-6
 - Recording Areas 3-8 through 3-16
- Scope Out Connectors, Using the 4-11
- Self-Testing 2-11
- Setup Condition Selectors 2-16
- Setup Conditions
 - Restoring 2-15 through 2-16
 - Saving 2-15 through 2-16
- Shift Button 2-14
- Shift Functions 2-14
- Shipping the HP 7090 1-6 through 1-7
- Signal Reconstruction, *See* Sample Rate, Minimum
- Standard Grid 3-20

S (Continued)

Standard Grid Button	3-20
Stop Button	2-15
Stopping Functions	2-15

Subject Index (Continued)

t

Time and Date	
Labeling the	6-1 through 6-2
Setting the	2-18 through 2-19
Total Time Setup Condition	3-8 through 3-9
Transparency Film, Plotting on	2-9 through 2-10
Transparency Pens	2-9
Trigger Level Setup Condition	5-5
Trigger Level, Defined	5-4
Trigger Mode Selector	5-2
Trigger Modes, Defined	5-1
Trigger Search	
Indicator	5-2
Status	5-1 through 5-2
Trigger Width Setup Condition	5-6
Trigger Width, Defined	5-5
Trigger Window, Defined	5-5 through 5-6

V

Ventilation Requirements	1-2
Versus-Chan3 Measurement	
Defined	3-2 through 3-3
Performing a Direct	4-3 through 4-4
Performing a Buffered	4-7 through 4-8
Versus-Time Measurement	
Defined	3-2 through 3-3
Performing a Direct	4-1 through 4-2
Performing a Buffered	4-7 through 4-8

Z

Zero Button	3-7
Zero Point	
Default	3-6
Defined	3-4
Positioning the	3-7
Rotated	3-20 through 3-21

